

SUGGESTED RETAIL PRICE LIST

Effective AUGUST 1, 2019

BECOBEEB



40 YEARS STRONG!



Since 1980 BEFCO has developed, tested, manufactured and improved lawn and ground care attachments right here in North Carolina. BEFCO's commitment to design and to manufacture all key components in our machines has earned the company its reputation for high quality manufacturing with no compromise.

Anyone who has owned a BEFCO unit will tell you that it is an investment that repays for itself many times over throughout the years. Customers know that when purchasing a BEFCO implement, support is always available if assistance is ever needed. This is why when people ask us what BEFCO stands for, we say

"Best Equipment a Farmer Can Own"!



INDEX**GROOMING MOWERS**

CYCLONE C30-CE5	2
CYCLONE C30	4
CYCLONE C50	6
CYCLONE C70	8
CYCLONE FLEX	10
CYCLONE SUPER-FLEX	12

FLAIL MOWERS, FLAIL SHREDDERS

HURRICANE H40	14
HURRICANE H40-S	16
HURRICANE H70	18
DESTROYER D90	20

CHIPPERS

BUSHMASTER	22
-------------------	-----------

ROTARY CUTTERS

TORNADO BRC	23
TORNADO RMD	24
TORNADO RHD	25

ROTARY TILLERS

TILL-RITE T30	26
TILL-RITE T40	28
TILL-RITE T50	30
TILL-RITE T60	32
TILL-RITE T70	34

SEEDERS, OVERSEEDERS

GREEN-RITE	36
SEED-RITE	38

POST HOLE DIGGERS

MOLE	40
-------------	-----------

FERTILIZER SPREADERS

BABY-HOP	42
POLY BABY-HOP	43
HOP	44
POLY-HOP	45
TURBO-HOP 301	46
TURBO-HOP 303	46

GROUND ENGAGE EQUIPMENT

CORE AERATOR SD	48
CORE AERATOR HD	49
SOIL PULVERIZERS SD	50
SOIL PULVERIZERS HD	51
BOX SCRAPER	52
GRADING SCRAPER	53
REAR BLADE SD	54
REAR BLADE HD	55
LANDSCAPE RAKE	56

HAY EQUIPMENT

SICKLE BAR MOWERS	57
FINGER WHEEL RAKES	58
FINGER WHEEL "V" RAKES	59
TEDDERS	60
WINDROWER RAKES	61

QUICK HITCH

QUICK HITCH	62
--------------------	-----------

OPTIONALS

63

CYCLONE C30-CE5



Three spindle engine driven grooming mower

- Ideal for lawn tractors, ATVs & UTVs.
- Rear discharge.
- 4 solid rubber tires to guarantee a perfectly level cut.
- Stamped steel reinforced wheel arm attached by 5 bolts for maintaining a consistent cutting height.
- Spindle shafts greased from the top for easy service.
- Hitch: Cat. 1 ball for rear mounting and 2" receiver hitch for front mounting.
- 10 gauge reinforced mower deck.
- Cutting heights: from 1" to 4".
- Heavy duty reinforced belts (BX).
- Powerful 11.5 HP Briggs & Stratton (OHV) engine with centrifugal clutch.
- 3 quart fuel tank.
- Safety kill switch.
- Heavy duty, one piece, balanced steel pulleys.
- Stamped steel wheel yokes.

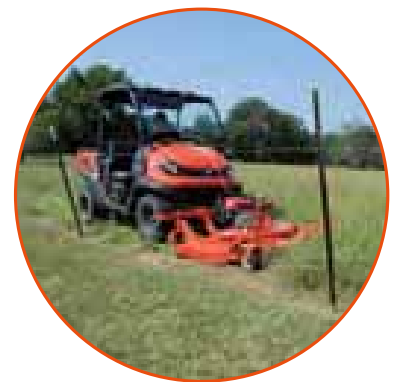

STANDARD



Reversible hitch for front or rear mounting



Capable of being center mounted or offset left or right



Up to 48" offset

C30-CE5H

in	in	in	lbs	lbs	rpm	fpm	N°	in	N°	N°-in	
60"	62"	0-48"	388	495	2,673	14,173	3	1"-4"	2 BX	4-8.4"x3.2"	Briggs & Stratton 11.5 HP

\$ 3,367



Front mount application with 2" receiver hitch



Height adjustment bar

CYCLONE C30

16-30 HP (12-22 KW)
540 rpm - cat. 1



Rear discharge three spindle grooming mower

- Highly engineered & rugged gearbox.
- Front & rear tractor mounting.
- 4 rubber swivel tires to guarantee a perfectly level cut.

- Floating 3 point linkage, cat. 1.
- 10 gauge reinforced mower deck.
- Stamped steel reinforced wheel arm attached by 5 bolts for maintaining a consistent cutting height.
- Stamped steel wheel yokes.
- Cutting heights: from 1" to 4".
- Spindle shafts greased from the top for easy service.
- Heavy duty reinforced belt (BX).
- Heavy duty, one piece, balanced steel pulleys.
- Heavy duty shielded PTO shaft (1 3/8" ASAE cat. 2).



Heavy duty reinforced belt (BX) with automatic belt tensioner



Axial grease fittings for easy and accurate lubrication

STANDARD

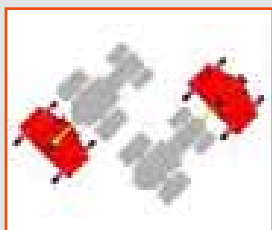

Reversible three point hitch for front or rear tractor mounting



Gearboxes manufactured by Befco















Stamped steel wheel arms attached by five bolts



Choice of hard or air tires



MODEL	C30-RD4H	C30-RD5H	C30-RD6H	C30-RD4A	C30-RD5A	C30-RD6A
	HARD TIRES			AIR TIRES		
 HP	16-30	20-30	25-30	16-30	20-30	25-30
 in	48"	60"	72"	48"	60"	72"
 in	51"	62"	74"	51"	62"	74"
 lbs	340	375	440	329	364	429
 lbs	440	490	570	429	479	559
 rpm	3,037	2,803	2,278	3,037	2,803	2,278
 fpm	13,188	14,763	14,566	13,188	14,763	14,566
 N°	3	3	3	3	3	3
 in	1"-4"	1"-4"	1"-4"	1"-4"	1"-4"	1"-4"
 N°	1 BX	1 BX	1 BX	1 BX	1 BX	1 BX
 N°-in	4-8.4"x3.2"	4-8.4"x3.2"	4-8.4"x3.2"	4-9"x3.5"	4-9"x3.5"	4-9"x3.5"
 1 3/8"	ASAE cat. 2	ASAE cat. 2	ASAE cat. 2	ASAE cat. 2	ASAE cat. 2	ASAE cat. 2
	\$ 2,621	\$ 2,754	\$ 3,001	\$ 2,595	\$ 2,728	\$ 2,975



CYCLONE C50

20-50 HP (15-37 KW)
540 rpm - cat. 1



Rear discharge three spindle grooming mower

- Highly engineered & rugged gearbox with cooling fins.
- Spiral gears guarantee strength and quietness.
- Cutting heights: from 1" to 5".
- Front & rear tractor mounting.
- 4 rubber swivel tires with bearings to guarantee a perfectly level cut.
- Stamped steel reinforced wheel arm attached by 8 bolts for maintaining a consistent cutting height.
- Floating 3 point linkage, cat. 1.
- 8 gauge reinforced mower deck.

- Spindle shafts greased from the top for easy service.
- Safety chain shield standard.
- Two heavy duty reinforced belts (SPBX).
- Heavy duty, one piece, balanced steel pulleys.
- Heavy duty shielded PTO shaft (1 3/8" ASAE cat. 3).
- Stamped steel wheel yokes.

STANDARD

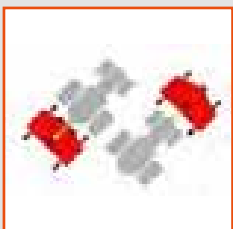

Reversible three point hitch for front & rear tractor mounting



Gearboxes, manufactured by Befco, equipped with spiral gears ensure better power transmission, increase longevity and reduce noise















Choice of standard blades, high lift blades, mulching blades and flat blades



Choice of hard or air tires with ball bearings



MODEL	C50-RD5H	C50-RD6H	C50-RD7H	C50-RD5A	C50-RD6A	C50-RD7A
	HARD TIRES			AIR TIRES		
 HP	20-50	25-50	30-50	20-50	25-50	30-50
 in	60"	72"	84"	60"	72"	84"
 in	62"	74"	86"	62"	74"	86"
 lbs	550	600	690	534	584	674
 lbs	665	730	835	649	714	819
 rpm	3,210	2,605	2,195	3,210	2,605	2,195
 fpm	16,929	16,732	16,338	16,929	16,732	16,338
 N°	3	3	3	3	3	3
 in	1"-5"	1"-5"	1"-5"	1"-5"	1"-5"	1"-5"
 N°	2 SPBX	2 SPBX	2 SPBX	2 SPBX	2 SPBX	2 SPBX
 N°-in	4-10"x3.2"	4-10"x3.2"	4-10"x3.2"	4-11"x4"	4-11"x4"	4-11"x4"
 1 3/8"	ASAE cat. 3	ASAE cat. 3	ASAE cat. 3	ASAE cat. 3	ASAE cat. 3	ASAE cat. 3
\$	\$ 3,647	\$ 3,856	4,506	\$ 3,599	\$ 3,808	\$ 4,459

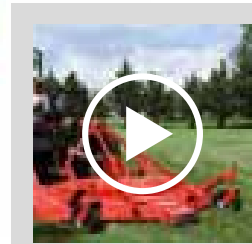

Axial grease fittings for easy and accurate spindle lubrication

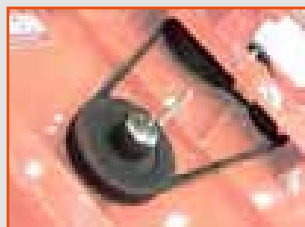

Two heavy duty reinforced belts (SPBX) with manual tensioner provide over 180° coverage of all pulleys and reduce belt maintenance





CYCLONE C70

30-70 HP (22-52 KW)
 540 rpm - cat. 1



Heavy duty rear discharge three spindle grooming mower

- Highly engineered & rugged gearbox with cooling fins.
- Cutting heights: from 1.3" to 5.3".
- Front & rear tractor mounting.
- 4 rubber swivel tires with bearings to guarantee a perfectly level cut.
- Stamped steel reinforced wheel arm attached by 8 bolts for maintaining a consistent cutting height.
- Floating 3 point linkage, cat. 1.
- Front antiscalping roller standard.

- 8 gauge reinforced mower deck.
- Three spindle rotors with free swinging blades per rotor.
- Spindle shafts greased from the top for easy service.
- Two heavy duty reinforced belts (CX).
- Heavy duty, one piece, balanced steel pulleys.
- Heavy duty shielded PTO shaft (1 3/8" ASAE cat. 4).
- Safety chain shield standard.
- Stamped steel wheel yokes.



MODEL		C70-090H	C70-110H	C70-090A	C70-110A
		HARD TIRES		AIR TIRES	
	HP	30-70	40-70	30-70	40-70
	in	90"	110"	90"	110"
	in	92"	112"	92"	112"
	lbs	1,237	1,390	1,137	1,290
	lbs	1,267	1,420	1,167	1,320
	rpm	1,750	1,562	1,750	1,562
	fpm	14,106	14,998	14,106	14,998
	N°	6	6	6	6
	in	1.3"-5.3"	1.3"-5.3"	1.3"-5.3"	1.3"-5.3"
	N°	2 CX	2 CX	2 CX	2 CX
	N°-in	4-12"x4"	4-12"x4"	4-13"x6.5"	4-13"x6.5"
	1 3/8"	ASAE cat. 4	ASAE cat. 4	ASAE cat. 4	ASAE cat. 4
\$		\$ 6,931	\$ 8,193	\$ 7,087	\$ 8,349



STANDARD

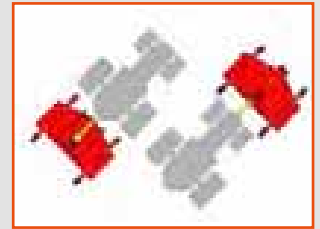

Reversible three point hitch for front or rear tractor mounting



Gearboxes manufactured by Befco



Stamped steel wheel arms attached by eight bolts

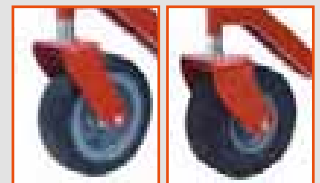

Choice of hard or air tires



Axial grease fittings for easy and accurate spindle lubrication



Chains provide safety from thrown objects



Standard front antiscalping roller



Rotor with free swinging blades

CYCLONE FLEX

25-80 HP (19-60 KW)
 540 rpm















Pull type gang grooming mowers

- Heavy duty transport frame.
- Cutting heights: from 1" to 5".
- Pull type mower with high flotation transport tires (20.5"x8"x10").
- Single action hydraulic folding wing system for easy transport & storage.
- Transport width 8'4" max.
- Telescoping wings that allow for adjustable cutting width to increase or decrease mower overlap.
- Constant velocity driveline with slip clutch (1 3/8" ASAE cat. 6).
- Stamped steel reinforced wheel arm attached by 8 bolts for maintaining a consistent cutting height.
- 3 front antiscalping rollers standard.
- Safety chain shield standard.
- 8 gauge reinforced mower decks.
- Remote safety locks for local transport & deck kick out attachments.
- Completely independent free floating mowing decks for a perfect cut on uneven terrain.
- Unique double pivot floating linkage.
- 12 rubber tires with bearings (4 per deck) to guarantee a perfectly level cut.
- Heavy duty, one piece, balanced steel pulleys.
- Two heavy duty reinforced belts per deck (SPBX).
- Single unit gearboxes with cooling fins.
- Spiral gears guarantee strength and quietness.
- Stamped steel wheel yokes.
- Single unit driveline with shear pin safety.

STANDARD



Gearboxes, manufactured by Befco, equipped with spiral gears ensure better power transmission, increase longevity and reduce noise

MODEL	312-FLXH	315-FLXH	317-FLXH	312-FLXA	315-FLXA	317-FLXA	
	HARD TIRES			AIR TIRES			
	HP	25-80	30-80	35-80	25-80	30-80	35-80
	ft	12'	15'	17'	12'	15'	17'
	in	91"	97"	100"	91"	97"	100"
	in	74"	92"	103"	74"	92"	103"
	lbs	2,742	2,874	2,995	2,694	2,826	2,947
	N°	9	9	9	9	9	9
	in	1"-5"	1"-5"	1"-5"	1"-5"	1"-5"	1"-5"
	N°	6 SPBX	6 SPBX	6 SPBX	6 SPBX	6 SPBX	6 SPBX
	N°-in	12-10"x3.2"	12-10"x3.2"	12-10"x3.2"	12-11"x4"	12-11"x4"	12-11"x4"
	N°/ft	2-4' mowers & 1-5' mower	2-5' mowers & 1-6' mower	3-6' mowers	2-4' mowers & 1-5' mower	2-5' mowers & 1-6' mower	3-6' mowers
	1 3/8"	ASAE cat. 6 cv, slip clutch	ASAE cat. 6 cv, slip clutch	ASAE cat. 6 cv, slip clutch	ASAE cat. 6 cv, slip clutch	ASAE cat. 6 cv, slip clutch	ASAE cat. 6 cv, slip clutch
		\$ 19,101	\$ 20,855	\$ 21,645	\$ 18,960	\$ 20,713	\$ 21,503

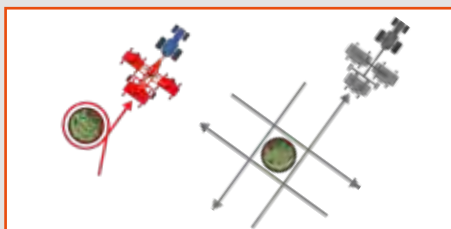

The frame design along with our CV driveline allows Flex mowers to circle trees and obstacles in one pass where competitors require multiple passes.



Hexagonal yokes on front tires of rear mower deck to prevent slippage on slopes



Standard front antiscaling roller



CYCLONE SUPER-FLEX

35-80 HP (26-60 KW)
540 rpm





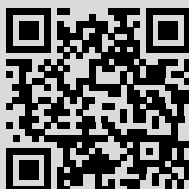
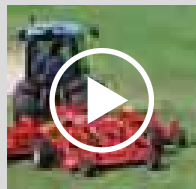







Pull type gang grooming mowers

- Extra heavy duty transport frame.
- Cutting heights: from 1" to 5".
- Pull type mower with high flotation transport tires (23"x10.5"x12").
- Single action hydraulic folding wing system for easy transport & storage.
- 3 front antiscalping rollers standard.
- Telescoping wings that allow for adjustable cutting width to increase or decrease mower overlap.
- Constant velocity driveline with slip clutch (1 3/8" ASAE cat. 6).
- Stamped steel reinforced wheel arm attached by 8 bolts for maintaining a consistent cutting height.
- Stamped steel wheel yokes.
- 8 gauge reinforced mower deck.



- Safety chain shield standard.
- Single unit driveline with shear pin safety.
- Remote safety locks for local transport & deck kick out attachments.
- Completely independent free floating mowing decks for a perfect cut on uneven terrain.
- Unique double pivot floating linkage.
- 12 rubber tires with bearings (4 per deck) to guarantee a perfectly level cut.
- Wide high flotation air tires 13"x6.5".
- Heavy duty, one piece, balanced steel pulleys.
- Two heavy duty reinforced belts per deck (SPBX).
- Single unit gearboxes with cooling fins.
- Spiral gears guarantee strength and quietness.



MODEL		412-SFLA	415-SFLA	417-SFLA	420-SFLA
	HP	35-80	40-80	45-80	50-80
	ft	12'	15'	17'	20'
	in	91"	97"	100"	114"
	in	74"	92"	103"	116"
	lbs	3,090	3,267	3,438	3,747
	N°	9	9	9	9
	in	1"-5"	1"-5"	1"-5"	1"-5"
	N°	6 SPBX	6 SPBX	6 SPBX	6 SPBX
	N°-in	12-13"x6.5"	12-13"x6.5"	12-13"x6.5"	12-13"x6.5"
	N°-ft	2-4' mowers & 1-5' mower	2-5' mowers & 1-6' mower	3-6' mowers	3-7' mowers
	1 3/8"	ASAE cat. 6 cv, slip clutch	ASAE cat. 6 cv, slip clutch	ASAE cat. 6 cv, slip clutch	ASAE cat. 6 cv, slip clutch
		\$ 22,280	\$ 23,426	\$ 25,396	\$ 28,668

STANDARD



Double pivot floating linkage for a perfect cut on uneven terrain



Telescopic wings that allow for adjustable cutting width to increase or decrease mower overlap



Gearboxes, manufactured by Befco, equipped with spiral gears to increase strength and quietness



Air tires 13"x6.5"

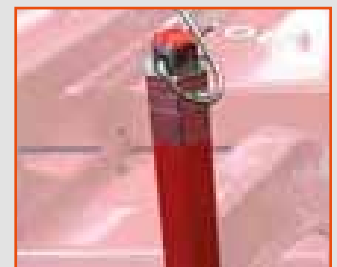

Hexagonal yokes on front tires of rear mower deck prevent slippage on slopes



Heavy duty center-splitter gearbox





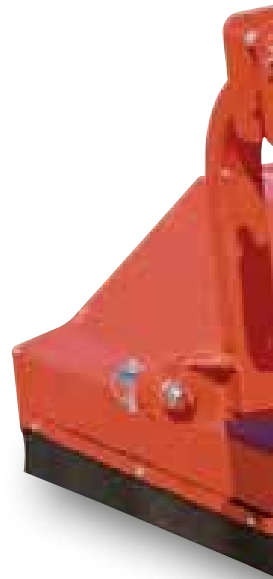







HURRICANE H40

16-40 HP (12-30 KW)
540 rpm - cat. 1



Flail mower

- Cutting heights: from 1" to 5".
- Choice of fine cut blades at 90° angles, reverse "Y" blades, paddle blades or hammer type blades.
- Dethatching blades available.
- Adjustable cutting height roller with scraper.
- Heavy duty shielded PTO shaft (1 3/8" ASAE cat. 3).
- Sealed rotor bearings.
- Front & rear tractor mounting.
- Electronically balanced rotor.
- Heavy duty, one piece, balanced steel pulleys.
- 2 Heavy duty reinforced notched belts (SPBX).
- Automatic belt tensioner.
- 3 point linkage, cat. 1.
- Floating top link.
- Highly engineered & rugged gearbox.
- Offset from center: 3" on H40-048, 8.5" on H40-060, & 6.5" on H40-072.
- Rubber safety shielding.

MODEL		H40-048	H40-060	H40-072
	HP	16-40	20-40	25-40
	in	48"	60"	72"
	in	54"	64"	76"
	lbs	418	456	528
	lbs	556	593	638
	rpm	2,278	2,278	2,278
	fpm	8,858	8,858	8,858
	N°	48	64	76
	in	1"-5"	1"-5"	1"-5"
	N°	2 SPBX	2 SPBX	2 SPBX
	1 3/8"	ASAE cat. 3	ASAE cat. 3	ASAE cat. 3
		\$ 3,488	\$ 3,739	\$ 4,115

STANDARD



Reversible three point hitch for front or rear tractor mounting



Gearbox manufactured by Befco



Choice of fine cut blades, dethatching blades, reverse 'Y' blades, paddle blades or hammer type blades



Double belt transmission with automatic belt tensioner



HURRICANE H40-S













16-40 HP (12-30 KW)
 540 rpm - cat. 1



Side-shift flail mower

- Cutting heights: from 3/4" to 2 3/8".
- Manual or optional hydraulic side-shift up to 16".
- Dual rear roller mounting position, inside or outside the cutting chamber.
- Manual belt tensioner without spring loaded idlers.
- Choice of fine cut blades at 90° angles, reverse "Y" blades, paddle blades or hammer type blades.
- Dethatching blades available.
- Adjustable cutting height roller with scraper or self cleaning roller when mounted inside the cutting chamber.
- Heavy duty shielded PTO shaft (1 3/8" ASAE cat. 3).
- Sealed rotor bearings.
- Front & rear tractor mounting.
- Heavy duty, one piece, balanced steel pulleys.
- 2 Heavy duty reinforced notched belts (SPBX).
- 3 point linkage, cat. 1.
- Standard front rubber safety shielding or optional front steel deflectors.



MODEL		H40-S48	H40-S60	H40-S72
	HP	16-40	20-40	25-40
	in	48"	60"	72"
	in	54"	64"	76"
	in	35"	46"	58"
	lbs	552	624	697
	lbs	690	762	835
	rpm	2,278	2,278	2,278
	fpm	8,858	8,858	8,858
	N°	48	64	76
	in	¾"-2 ¾"	¾"-2 ¾"	¾"-2 ¾"
	N°	2 SPBX	2 SPBX	2 SPBX
	1 ¾"	ASAE cat. 3	ASAE cat. 3	ASAE cat. 3
\$		\$ 3,788	\$ 4,089	\$ 4,515



STANDARD

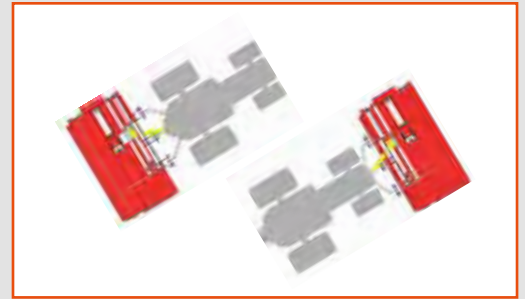

Reversible three point hitch for front or rear tractor mounting

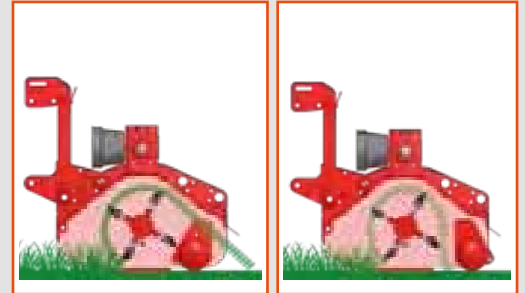

Dual rear roller mounting position, inside or outside the cutting chamber



Manual or hydraulic side-shift up to 16"



Manual belt tensioning

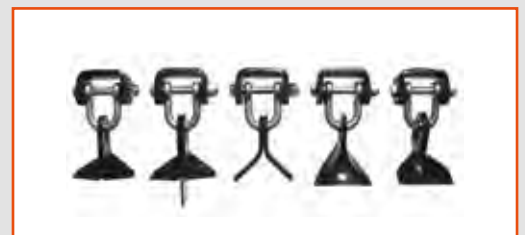

Choice of fine cut blades, detaching blades, reverse 'Y' blades, paddle blades or hammer type blades

HURRICANE H70

30-70 HP (22-52 KW)
540 rpm - cat. 1 & 2















Flail mower

- Cutting heights: from 3/4" to 6".
- Choice of fine cut blades at 90° angles, reverse "Y" blades, paddle blades or hammer type blades.
- Dethatching blades available.
- Adjustable cutting height roller with scraper.
- Driveline with overrunning clutch (1 3/8" ASAE cat. 4).
- Highly engineered & rugged gearbox.
- Belt shield fender.
- Front & rear tractor mounting.
- Electronically balanced rotor.
- Heavy duty, one piece, balanced steel pulleys.



- 2 heavy duty reinforced notched belts (CX).
- Manual belt tensioner.
- 3 point linkage, cat. 1 & 2.
- Floating top link.
- Forward & reverse rotor rotation; clockwise is standard.
- Cast iron rotor supports with spherical roller bearings.
- Rubber safety shielding.
- Replaceable skids.



MODEL		H70-060	H70-072	H70-088	H80-100
	HP	30-70	35-70	40-70	50-80
	in	60"	72"	88"	100"
	in	71"	85"	99"	110"
	lbs	869	955	1,078	1,486
	lbs	1,045	1,145	1,298	1,636
	rpm	2,080	2,080	2,080	1,873
	fpm	8,464	8,464	8,464	8,268
	N°	64	80	96	104
	in	3/4"-6"	3/4"-6"	3/4"-6"	3/4"-6"
	N°	2 CX	2 CX	2 CX	2 CX
	1 3/8"	ASAE cat. 4 overrunning clutch	ASAE cat. 4 overrunning clutch	ASAE cat. 4 overrunning clutch	ASAE cat. 6 overrunning clutch
		\$ 6,980	\$ 7,458	\$ 7,947	\$ 11,472



STANDARD



Reversible three point hitch for front or rear tractor mounting



Gearboxes manufactured by Befco



Belt shield fender



Cast iron rotor support with spherical roller bearings



Replaceable side skids

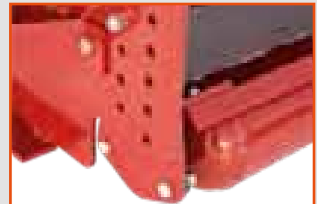

Adjustable cutting height roller with scraper



Choice of fine cut blades, dethatching blades, reverse 'Y' blades, paddle blades or hammer type blades

DESTROYER D90

40-90 HP (30-67 KW)
540 rpm - cat. 1 & 2

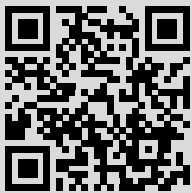

Commercial flail shredder with hydraulic side-shift

- Cutting heights: from 3/4" to 5".
- 3 point linkage, cat. 1 & 2.
- Front & rear tractor mounting.
- Driveline with overrunning clutch (1 3/8" ASAE cat. 6).
- Belt driven transmission with four heavy duty XPBX type belts and manual belt tensioner.
- Hydraulic side-shift with dual remotes.
- 12" side-shift on 60" model 16" on 72" & 88" models.
- Heavy duty hammer type blades.
- 2" cutting capacity.
- Rotor diameter 5 1/4", 5/16" thick rotor tube.
- Height adjustment rear roller with scraper standard.
- Rear roller diameter 6 5/8", 3/16" thick rotor tube.

MODEL		D90-060	D90-072	D90-088
	HP	40-90	50-90	60-90
	in	60"	72"	88"
	in	69"	81"	96"
	in	43"	54"	61"
	lbs	1,257	1,345	1,491
	lbs	1,360	1,450	1,600
	rpm	1,961	1,961	1,961
	fpm	8,268	8,268	8,268
	N°	16	20	24
	in	3/4"-5"	3/4"-5"	3/4"-5"
	N°	4 XPBX	4 XPBX	4 XPBX
	1 3/8"	ASAE cat. 6 overrunning clutch	ASAE cat. 6 overrunning clutch	ASAE cat. 6 overrunning clutch
		\$ 8,903	\$ 9,441	\$ 9,931



STANDARD



Reversible three point hitch for front or rear tractor mounting



Hammer type blades ideal for stalks up to 2" in diameter



Hydraulic cylinder for side shift

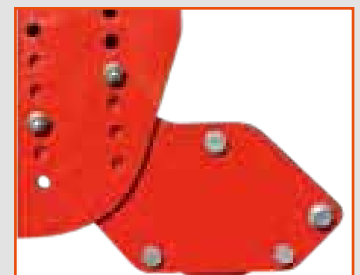

Rear roller for cutting height adjustment equipped with roller scraper



Four belts transmission



BUSHMASTER

30-50 HP (22-37 KW)
540 rpm - cat. 1



STANDARD



Variable speed feed roller



Heavy duty BX type belt driven transmission



Consistent and fine wood chips



360° adjustable blower pipe extension

MODEL	BM6-800	
	HP	30-50
	lbs	900
	lbs	1,036
		360° swivel
	N°	6 BX
	in	6"
	rpm	1,512
	fpm	9,252
	N°	2
	1 3/8"	ASAE cat. 4
		\$ 8,495

Wood chipper

- Variable speed feed roller 70 or 45 fpm.
- Drum style chipping wheel.
- Two knives (7.5"x3"x3/8") modified A8 tool steel.
- Continuous chipping capacity of up to 6".
- Power feed on/off control bar.
- 3 point linkage, cat. 1.
- Heavy duty shielded PTO shaft (1 3/8" ASAE cat. 4).
- Built in high volume blower with optional 15" extension.
- Easy access to belts and chipper knives.





TORNADO BRC

20-60 HP (15-45 KW)
540 rpm - cat. 1



Standard duty rotary cutters

- Cutting heights: from 1" to 9 1/4".
- 10 gauge reinforced deck.
- Heavy duty shielded PTO shaft with shear bolt or slip clutch safety (1 3/8" ASAE cat. 4).
- Oval stump jumper standard on 48", 60" & 72" sizes.
- Spring steel blades.
- 1" cutting capacity.
- Front & rear safety shields standard.
- Laminated tail wheel (4"x8"x15").
- 3 point linkage, cat. 1.
- Floating top link.
- Round back frame.

MODEL		BRC-142	BRC-148	BRC-160	BRC-172	BRC-242	BRC-248	BRC-260	BRC-272
		SHEAR BOLT				SLIP CLUTCH			
	HP	20-60	25-60	30-60	35-60	20-60	25-60	30-60	35-60
	in	42"	48"	60"	72"	42"	48"	60"	72"
	in	47"	56"	68"	79"	47"	56"	68"	79"
	lbs	383	443	528	601	401	461	539	612
	lbs	397	457	591	675	415	475	613	686
	rpm	1,042	1,042	794	794	1,042	1,042	794	794
	fpm	11,437	12,560	11,948	14,232	11,437	12,560	11,948	14,232
	N°-in	2-3/8"x 2 3/4"	2-3/8"x 2 3/4"	2-1/2"x 3"	2-1/2"x 3"	2-3/8"x 2 3/4"	2-3/8"x 2 3/4"	2-1/2"x 3"	2-1/2"x 3"
	in	1"-9 1/4"	1"-9 1/4"	1"-9 1/4"	1"-9 1/4"	1"-9 1/4"	1"-9 1/4"	1"-9 1/4"	1"-9 1/4"
	N°-in	1-4"x8"x15"	1-4"x8"x15"	1-4"x8"x15"	1-4"x8"x15"	1-4"x8"x15"	1-4"x8"x15"	1-4"x8"x15"	1-4"x8"x15"
	1 3/8"	ASAE cat. 4 shear bolt	ASAE cat. 4 shear bolt	ASAE cat. 4 shear bolt	ASAE cat. 4 shear bolt	ASAE cat. 4 slip clutch	ASAE cat. 4 slip clutch	ASAE cat. 4 slip clutch	ASAE cat. 4 slip clutch
		\$ 1,590	\$ 1,943	\$ 2,138	\$ 2,482	\$ 1,766	\$ 2,118	\$ 2,313	\$ 2,658

WARNING: Because of possible injury from thrown objects, all rotary cutters are potentially dangerous. Any rotary cutter intended for use along roadways or other locations where people may be present must be used with safety shielding in place.

TORNADO RMD

35-80 HP (26-60 KW)
540 rpm - cat. 1

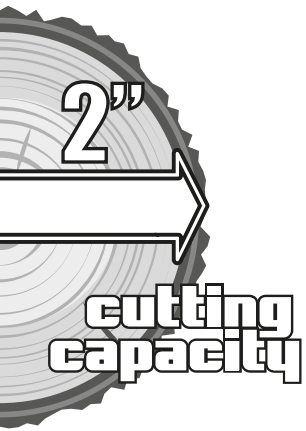

Medium duty rotary cutters

- Cutting heights: from 1" to 9 1/4".
- Replaceable skids.
- Highly engineered & rugged gearbox.
- Heavy duty shielded PTO shaft with slip clutch safety (1 3/8" ASAE cat. 4).
- 3 point linkage, cat. 1.
- Floating top link.
- Exceptionally heavy duty 1/2"x4" spring steel blades.
- 2" cutting capacity.
- Laminated tail wheel with tapered roller bearings (4"x8"x15").
- Oval heavy duty stump jumper standard.
- Heavy duty reinforced 8 gauge deck.
- Front & rear protective chain shields standard.

WARNING:

Because of possible injury from thrown objects, all rotary cutters are potentially dangerous. Any rotary cutter intended for use along roadways or other locations where people may be present must be used with safety shielding in place.

MODEL		RMD-360	RMD-372
	HP	35-80	40-80
	in	60"	72"
	in	68"	80"
	lbs	695	785
	lbs	695	785
	rpm	855	855
	fpm	13,189	15,748
	N°-in	2-1/2"x4"	2-1/2"x4"
	in	1"-9 1/4"	1"-9 1/4"
	N°-in	1-4"x8"x15"	1-4"x8"x15"
	1 3/8"	ASAE cat. 4 slip clutch	ASAE cat. 4 slip clutch
		\$ 3,880	\$ 4,312

STANDARD



Laminated tail wheel



Carbon steel rotor with free swinging blades

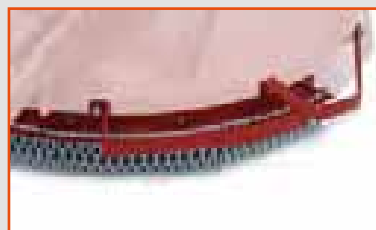

Safety chains & shields



Replaceable side skids



TORNADO RHD

50-100 HP (37-74 KW)
540 rpm - cat. 1 & 2















cutting capacity

Heavy duty rotary cutters

- Cutting heights: from 2" to 8".
- Replaceable skids.
- Highly engineered & rugged gearbox.
- Heavy duty shielded PTO shaft with slip clutch safety (1 3/8" ASAE cat. 6).
- 3 point linkage, cat. 1 & 2.
- Floating top link.
- Front & rear protective chain shields standard.
- Exceptionally heavy duty 1/2"x4" spring steel blades.
- 3" cutting capacity.
- Laminated tail wheel with tapered roller bearings (5"x8"x15").
- Oval heavy duty stump jumper standard.
- Heavy duty reinforced deck.



MODEL	RHD-472	RHD-484	
	HP	50-100	60-100
	in	72"	84"
	in	76"	88"
	lbs	1,025	1,200
	lbs	1,025	1,200
	rpm	748	748
	fpm	13,878	16,191
	N°-in	2-1/2"x4"	2-1/2"x4"
	in	2"- 8"	2"- 8"
	N°-in	1-5"x8"x15"	1-5"x8"x15"
	1 3/8"	ASAE cat. 6 slip clutch	ASAE cat. 6 slip clutch
		\$ 4,866	\$ 5,562

WARNING:

Because of possible injury from thrown objects, all rotary cutters are potentially dangerous. Any rotary cutter intended for use along roadways or other locations where people may be present must be used with safety shielding in place.















Heavy duty free swinging blades mounted on a high carbon steel rotor protected by an oval stump jumper



TILL-RITE T30

16-30 HP (12-22 KW)
540 or 2000 rpm - cat. 1



MODEL	T30-134	T30-142	T30-150	T30-234	T30-242	T30-250	T30-534	T30-542	T30-550
	SHEAR BOLT 540 rpm			SLIP CLUTCH 540 rpm			SHEAR BOLT 2000 rpm		
 HP	16-30	20-30	25-30	16-30	20-30	25-30	16-30	20-30	25-30
 in	34"	42"	50"	34"	42"	50"	34"	42"	50"
 in	39"	47"	55"	39"	47"	55"	39"	47"	55"
 in	24"	32"	40"	24"	32"	40"	24"	32"	40"
 lbs	297	341	374	308	352	385	297	341	374
 lbs	387	430	463	398	441	474	387	430	463
 N°	4	5	6	4	5	6	4	5	6
 N°	16	20	24	16	20	24	16	20	24
 z	14-16	14-16	14-16	14-16	14-16	14-16	9-22	9-22	9-22
 rpm	205	205	205	205	205	205	237	237	237
 in	7 1/4"	7 1/4"	7 1/4"	7 1/4"	7 1/4"	7 1/4"	7 1/4"	7 1/4"	7 1/4"
 1 3/8"	ASAE cat. 2 shear bolt	ASAE cat. 2 shear bolt	ASAE cat. 2 shear bolt	ASAE cat. 3 slip clutch	ASAE cat. 3 slip clutch	ASAE cat. 3 slip clutch	ASAE cat. 2 shear bolt	ASAE cat. 2 shear bolt	ASAE cat. 2 shear bolt
	\$ 2,283	\$ 2,357	\$ 2,492	\$ 2,375	\$ 2,449	\$ 2,584	\$ 3,023	\$ 3,097	\$ 3,232

Rotary tiller with manual side-shift Forward or reverse tilling rotation

- Highly engineered & rugged gearbox.
- Smooth manual side-shift system.
- Adjustable side skids for working depth control.
- Heavy duty shielded PTO shaft with shear bolt coupling (1 3/8" ASAE cat. 2) or slip clutch safety (1 3/8" ASAE cat. 3).
- Max. working depth 7 1/4".
- Parking stand.
- Reinforced lateral ASA 60 chain drive transmission in oil bath.
- Four blades per flange.
- High carbon solid steel round rotor shaft allows for a deeper working depth.
- Outward turned blades keep the rotor supports clean and maximize working width.
- Heavy duty full size blades.
- 3 point linkage, cat. 1.

STANDARD



Manual side-shift

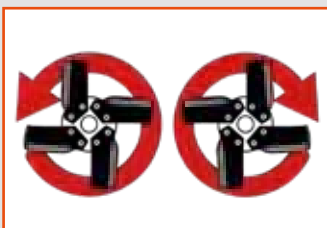

Front or rear blade rotation



Gearbox manufactured by Befco



Lateral ASA 60 chain drive transmission in oil bath



Side skids for working depth control



TILL-RITE T40

20-40 HP (15-30 KW)
540 rpm - cat. 1













Rotary tiller with manual side-shift Forward or reverse tilling rotation

- Highly engineered & rugged gearbox.
- Smooth manual side-shift system.
- Adjustable side skids for working depth control.
- Heavy duty shielded PTO shaft with shear bolt coupling or slip clutch safety (1 3/8" ASAE cat. 3).
- Exchangeable sprockets for two working speeds.
- Flanged rotor shaft for easy removal & service.
- Parking stand.
- 3 point linkage, cat. 1.
- Lateral ASA 80 chain drive transmission in oil bath.
- Four blades per flange.



- High carbon solid steel round rotor shaft allows for a deeper working depth.
- Outward turned blades keep the rotor supports clean and maximize working width.
- Heavy duty full size blades.
- Wear protection on chain case.
- Max. working depth 7 1/4".



MODEL	T40-142	T40-150	T40-158	T40-166	T40-242	T40-250	T40-258	T40-266
	SHEAR BOLT				SLIP CLUTCH			
 HP	20-40	25-40	30-40	32-40	20-40	25-40	30-40	32-40
 in	42"	50"	58"	66"	42"	50"	58"	66"
 in	47"	55"	63"	72"	47"	55"	63"	72"
 in	32"	40"	48"	56"	32"	40"	48"	56"
 lbs	363	407	451	518	373	417	461	530
 lbs	481	519	540	607	491	529	550	619
 N°	5	6	7	8	5	6	7	8
 N°	20	24	28	32	20	24	28	32
 z	11-14	11-14	11-14	11-14	11-14	11-14	11-14	11-14
 rpm	231/375	231/375	231/375	231/375	231/375	231/375	231/375	231/375
 in	7 1/4"	7 1/4"	7 1/4"	7 1/4"	7 1/4"	7 1/4"	7 1/4"	7 1/4"
 1 3/8"	ASAE cat. 3 shear bolt	ASAE cat. 3 shear bolt	ASAE cat. 3 shear bolt	ASAE cat. 3 shear bolt	ASAE cat. 3 slip clutch	ASAE cat. 3 slip clutch	ASAE cat. 3 slip clutch	ASAE cat. 3 slip clutch
	\$ 2,831	\$ 2,950	\$ 3,053	\$ 3,357	\$ 2,923	\$ 3,042	\$ 3,145	\$ 3,449

STANDARD



Manual side-shift

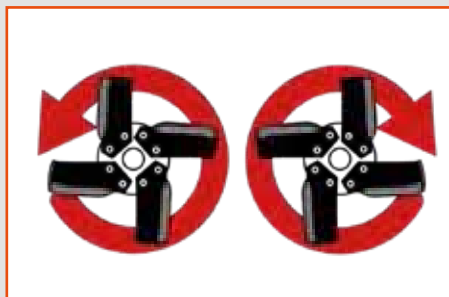

Front or rear blade rotation



Gearbox manufactured by Befco



Lateral ASA 80 chain drive transmission in oil bath



Stamped steel rotor shaft supports and transmission



Rotor shaft with flanges for easy blade replacement



TILL-RITE T50













25-50 HP (19-37 KW)
 540 rpm - cat. 1



Rotary tiller with manual side-shift Forward or reverse tilling rotation

- Highly engineered & rugged gearbox.
- Smooth manual side-shift system.
- Adjustable side skids for working depth control.
- Heavy duty shielded PTO shaft with slip clutch safety (1 3/8" ASAE cat. 4).
- Exchangeable sprockets for two working speeds.
- Flanged rotor shaft for easy removal & service.
- Parking stand.
- 3 point linkage, cat. 1.
- Lateral ASA 100 chain drive transmission in oil bath.
- Standard six blades per flange for greater stability and finer soil pulverization.
- Outward turned blades keep the rotor supports clean and maximize working width.
- Heavy duty full size tiller blades.
- Wear protection on chain case.
- Max. working depth 8 3/8".



MODEL		T50-350	T50-358	T50-366
	HP	25-50	30-50	35-50
	in	50"	58"	66"
	in	55"	63"	72"
	in	40"	48"	56"
	lbs	481	528	575
	lbs	625	670	708
	N°	6	7	8
	N°	36	42	48
	z	10-13	10-13	10-13
	rpm	226/383	226/383	226/383
	in	8 3/8"	8 3/8"	8 3/8"
	1 3/8"	ASAE cat. 4 slip clutch	ASAE cat. 4 slip clutch	ASAE cat. 4 slip clutch
		\$ 3,652	\$ 3,775	\$ 3,969



STANDARD



Manual side-shift

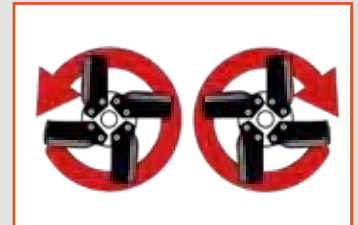

Front or rear blade rotation



Gearbox manufactured by Befco



Lateral ASA 100 chain drive transmission in oil bath



Stamped steel rotor shaft supports and transmission



Rotor with 6 blades per flange

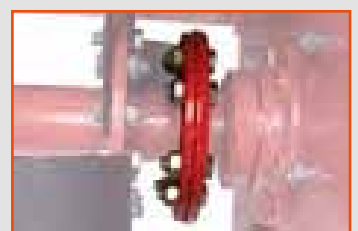

Rotor shaft with flanges for easy blade replacement











TILL-RITE T60

35-60 HP (26-45 KW)
540 rpm - cat. 1



Rotary tiller with manual side-shift Forward or reverse tilling rotation

- Highly engineered & rugged gearbox.
- Smooth manual side-shift system.
- Adjustable side skids for working depth control.
- Heavy duty shielded PTO shaft with slip clutch safety (1 3/8" ASAE cat. 6).
- Flanged rotor shaft for easy removal & service.
- Parking stand.
- 3 point linkage, cat. 1.
- Lateral ASA 100 chain drive transmission in oil bath.
- Standard six blades per flange for greater stability and finer soil pulverization.
- Outward turned blades keep the rotor supports clean and maximize working width.
- Heavy duty full size tiller blades.
- Wear protection on chain case.
- Max. working depth 8 3/4".

MODEL		T60-366	T60-374
	HP	35-60	40-60
	in	66"	74"
	in	72"	81"
	in	56"	63"
	lbs	740	798
	lbs	864	910
	N°	8	9
	N°	48	54
	z	12-14	12-14
	rpm	221	221
	in	8 ¾"	8 ¾"
	1 ½"	ASAE cat. 6 slip clutch	ASAE cat. 6 slip clutch
		\$ 4,960	\$ 5,161

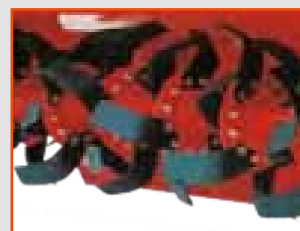

Rotor with 6 blades per flange



Manual side-shift

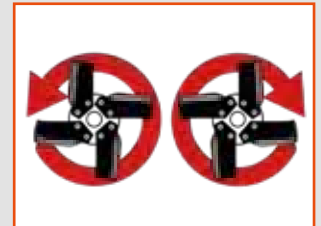

Front or rear blade rotation



Gearbox manufactured by Befco



Lateral ASA 100 chain drive transmission in oil bath



Stamped steel rotor shaft supports and transmission

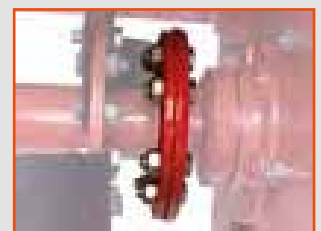

Rotor shaft with flanges for easy blade replacement

TILL-RITE T70

40-70 HP (30-52 KW)
540 rpm - cat. 1



Rotary tiller

Forward or reverse tilling rotation

- Highly engineered & rugged gearbox.
- Adjustable side skids for working depth control.
- Heavy duty shielded PTO shaft with slip clutch safety (1 3/8" ASAE cat. 6).
- Flanged rotor shaft for easy removal & service.
- Parking stand.
- 3 point linkage, cat. 1.
- Lateral ASA 100 chain drive transmission in oil bath.
- Standard six blades per flange for greater stability and finer soil pulverization.
- Outward turned blades keep the rotor supports clean and maximize working width.
- Heavy duty full size tiller blades.
- Wear protection on chain case.
- Max. working depth 8 3/4".



T70-382

										
HP	in	in	lbs	lbs	N°	N°	z	rpm	in	1 3/8"
40-70	82"	88"	879	1,009	10	60	12-14	221	8 3/4"	ASAE cat. 6 slip clutch

\$ 5,403



STANDARD

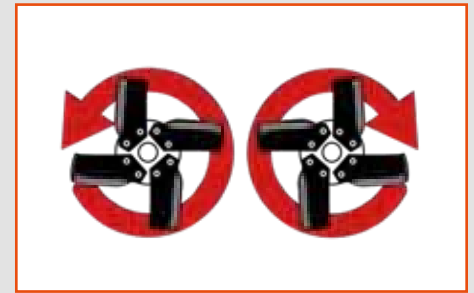

Front or rear blade rotation



Gearbox manufactured by Befco



Lateral ASA 100 chain drive transmission in oil bath

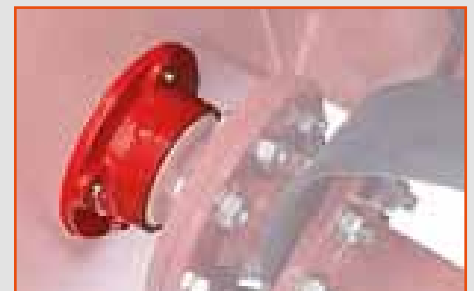

Stamped steel rotor shaft supports and transmission

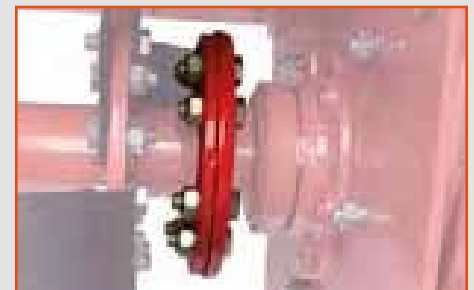















Rotor shaft with flanges for easy blade replacement

GREEN-RITE GRT25-70 HP (19-52 KW)
540 rpm - cat. 1**Overseeder-aerator
& seeder-cultivator**

- Special 2-¹³/₁₆" spacing on rotor for aerating with 3 knives per flange; 4 knives on model 282.
- 2" to 3" suggested working depth with aerator rotor, 7 ¹/₄" working depth with tiller rotor; 8 ³/₄" on on model 282.
- Seed covering/dethatching adjustable tickler tines.
- High precision metering seed cups made from a nylon/fiberglass composite.
- Parking stand.
- Ground drive system for seed hopper.
- Large capacity seed hopper with agitator.
- Heavy duty shielded PTO shaft with slip clutch safety (1 ³/₈" ASAE cat. 3 for models 250, 258 & 266, cat. 6 for model 282).
- Corrugated depth control roller made with low weight nylon/fiberglass roller rings.
- Double sided, extra thin profile razor blades reduce impact when aerating over existing turf (available on request).



MODEL		GRT-250	GRT-258	GRT-266	GRT-282
	HP	25-45	30-45	32-45	40-70
	in	50"	58"	66"	82"
	in	57"	66"	74"	89"
	lbs	910	998	1,170	1,500
	lbs	1,160	1,245	1,390	1,760
	cu.ft	4.60	5.30	6.00	7.60
	N°	7	8	9	11
	N°	15	18	21	26
	N°	43	52	61	104
	z	11-14	11-14	11-14	12-14
	rpm	231	231	231	221
	in	7 1/4"	7 1/4"	7 1/4"	8 3/4"
	1 3/8"	ASAE cat. 3 slip clutch	ASAE cat. 3 slip clutch	ASAE cat. 3 slip clutch	ASAE cat. 6 slip clutch
		\$ 9,298	\$ 9,558	\$ 10,721	\$ 13,815

STANDARD



Aerator rotor with straight blades with 2-13/16" flange spacing



Corrugated roller with nylon/fiberglass rings to compact the ground for optimal seed germination

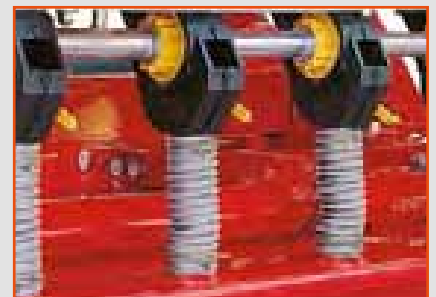

Precise seed metering cups



Seed calibration handle

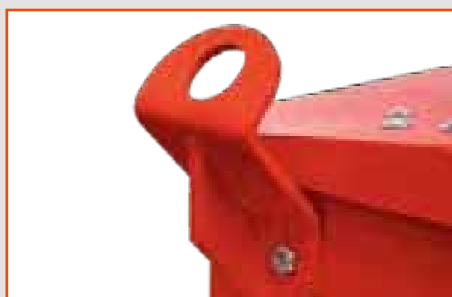

Lift hooks easy loading and unloading

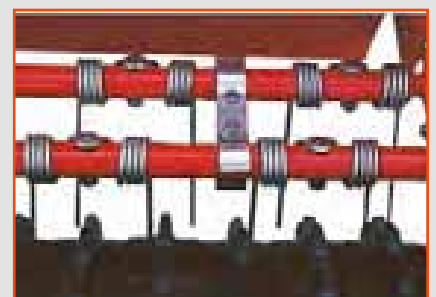







Tickler tines for partial or complete seed incorporation into the ground

SEED-RITE SRT25-70 HP (19-52 KW)
cat. 1**Primary seeder**

- 3 point linkage, cat. 1.
- 74" seeding width.
- Heavy duty frame.
- Heavy duty lid with seed splash guard.
- Hopper capacity 7.00 cu. ft.
- Seed box with steel shaft agitator.
- 10 high precision metering seed cups.
- Two lift hooks.
- Wide range of calibration settings per acre.
- Wind guarded seed drop.
- ASA 50 chains with chain tensioners.
- Front 11 1/2" diameter corrugated roller with 28 rings to drive the seed hopper.
- Rear corrugated roller with 29 rings, 9 1/2" in diameter made with low weight nylon/fiberglass.
- Roller spindles: 1 3/8" front and rear, with greasable bearings.
- Two spring-tine track removers.



SRT-074

									
HP	in	in	lbs	lbs		cu.ft	N°	N°-Ø	N°-Ø
25-70	74"	80"	1,008	1,190	ASA 50	7	10	28-11 1/2"	29-9 1/2"

\$ 6,204



STANDARD



Dual front and rear corrugated roller equipped with nylon/fiberglass rings



Lift hooks easy loading and unloading



Precise seed metering cups



Spring-tine tractor tire track removers



Seed distribution engaged by ASA 50 chain transmission



MOLE 100 / 200 / 300 / 400

15-90 HP (11-67 KW)
 540 rpm - cat. 1 & 2

Post hole diggers & augers

- Heavy duty boom and yoke for extra strength and long lasting service.
- Choice of 6", 9", 12", 18", 24" & 30" augers.
- Rugged dependable gearbox at 540 rpm provides constant digging power.
- Individually replaceable knives and point.
- Fully welded flighting on all augers.
- Reinforced mounting collar on all augers.
- Safety shielding around auger & PTO.
- 2" output shaft on 200, 300 & 400 series.
- 1 3/8" output shaft with 5/8" adapter bushing on 100 series.
- Heavy duty shielded PTO shaft (1 3/8" ASAE cat. 3) on 200, 300 & 400 series.
- Heavy duty shielded PTO shaft (1 3/8" ASAE cat. 2) on 100 series.
- Fish-tail point standard.

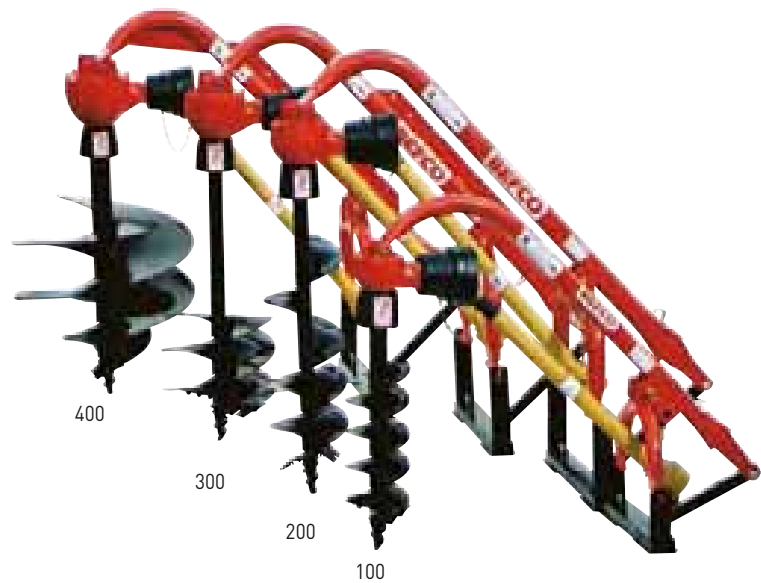

STANDARD



Reinforced frame and three point hitch on model 300-512 & 400-512



Driveline with shear pin safety



Hook-up stand

MODEL	DIGGERS			
	100-512	200-512	300-512	400-512
HP	15-25	18-40	18-50	18-90
Ø in	2 7/8"	3 1/2"	3 1/2" reinforced	3 1/2" reinforced
Ø in	2 3/8"	2 7/8"	2 7/8" reinforced	2 7/8" reinforced
rpm	180	180	154	135
	3:1	3:1	3.5:1	4:1
lbs	112	200	230	260
lbs	165	235	275	305
	limited Cat.1	Cat.1	Cat.1&2	Cat.1&2
1 3/8"	ASAE cat. 2 shear bolt	ASAE cat. 3 shear bolt	ASAE cat. 3 shear bolt	ASAE cat. 3 shear bolt
\$	\$ 1,095	\$ 1,177	\$ 1,429	\$ 1,736

MODEL	AUGERS									
	* 106-531	* 109-531	* 112-531	206-531	209-531	212-531	** 218-531	** 224-531	** 230-531	
in	6"	9"	12"	6"	9"	12"	18"	24"	30"	
L in	36"	36"	36"	48"	48"	48"	48"	48"	44"	
lbs	23	40	44	30	52	58	67	100	214	
S in	Single 3/16"	Double 3/16"	Double 3/16"	Single 3/16"	Double 3/16"	Double 3/16"	Double 1/4"	Double 1/4"	Double 15" & 30" 3/16"	
\$	\$ 321	\$ 336	\$ 427	\$ 329	\$ 377	\$ 447	\$ 607	\$ 817	\$ 1,583	

All post hole diggers are crated 2 each. Add \$50 net for single order units.

* Recommended for model 100-512.

** Available only for models 300-512 & 400-512.



Choice of 6, 9, 12, 18, 24 and 30" augers



Replaceable knives and points

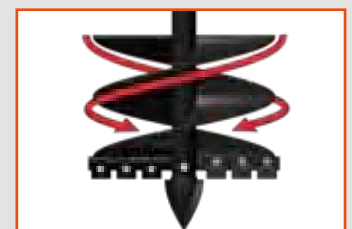

Heavy duty double flighting on all augers

BABY-HOP POLY BABY-HOP







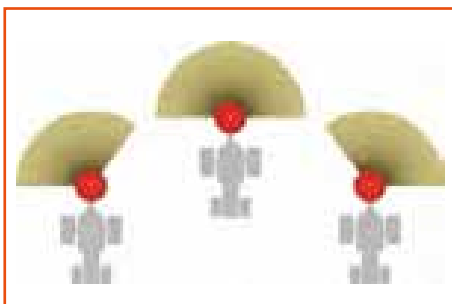

Fertilizer spreaders Ground driven pull type hitch

- One piece seamless hopper.
- Even left-center-right spread pattern.
- High flotation air tires.
- Easy connecting pull type hitch.
- Sturdy tubular frame.
- Hopper leveling adjustment.
- Sealed heavy duty gearbox with metal gears.
- Ground controlled distribution.
- Polyethylene hopper with stainless steel bottom standard on models 103-230 & 106-230.



Adjustable spread pattern

MODEL	BABY-HOP		POLY BABY-HOP	
	103-130	106-130	103-230	106-230
 lbs	62	84	62	84
 lbs	100	125	100	125
 cu.ft/lbs	3.71 / 237	5.30 / 339	3.71 / 237	5.30 / 339
 ft	3'-20"	3'-20"	3'-20"	3'-20"
 in	32"	35"	32"	35"
 in	39.6"	44.4"	39.6"	44.4"
 N°-in	2-13"x 6"	2-16"x 8"	2-13"x 6"	2-16"x 8"
\$	\$ 763	\$ 1,011	\$ 848	\$ 1,097

NOTE: Poundage capacity calculated @ 13-13-13 fertilizer weight of 64 lbs. per cu. ft.



STANDARD



Gate opening control



Sealed gearbox manufactured by Befco with metal gears

STANDARD



Bottom plate in stainless steel









HOP / POLY-HOP

16-50 HP (12-37 KW)
540 rpm - cat. 1



Fertilizer spreaders

- One piece seamless hopper.
- Selective double gate opening on 206, 209 & 212.
- Adjustable ejector spoon to center spread on 203 model.
- Sealed heavy duty gearbox.
- Fixed agitator.
- Adjustable spreading fins on 209 & 212 models.
- Heavy duty shielded PTO shaft (1 3/8" ASAE cat. 1).
- Sturdy tubular frame.
- 3 point linkage, limited cat. 1 on 203 & 206 models, cat. 1 on 209 & 212 models.
- Quick hitch compatible standard on models 209, 212 and optional on models 203.
- Safety shields standard.

MODEL		HOP			
		203-120	206-121	209-121	212-121
	HP	16-30	16-30	20-50	20-50
	lbs	81	102	125	136
	lbs	116	145	160	171
	cu.ft/lbs	3.71 / 237	5.30 / 339	8.58 / 549	11.95 / 765
	ft	23'	23'	46'	46'
	in	32"	35"	42"	48"
	in	31"	34"	40"	46"
	1 3/8"	ASAE cat. 1	ASAE cat. 1	ASAE cat. 1	ASAE cat. 1
		\$ 748	\$ 777	\$ 818	\$ 861

NOTE: Poundage capacity calculated @ 13-13-13 fertilizer weight of 64 lbs. per cu. ft.
All Hop fertilizers are priced at 2 per pallet. Add \$25 net for single unit orders.

Fertilizer spreaders with polyethylene hoppers

- Polyethylene hopper with stainless steel bottom standard.
- Sturdy tubular frame.
- Selective double opening gate on 206, 209 & 212 models.
- Heavy duty shielded PTO shaft (1 3/8" ASAE cat. 1).
- Sealed heavy duty gearbox.
- Fixed agitator.
- 3 point linkage, limited cat. 1 on 203 & 206 models, cat. 1 on 209 & 212 models.
- Quick hitch compatible standard on models 209, 212 and optional on models 203.
- Safety shields standard.

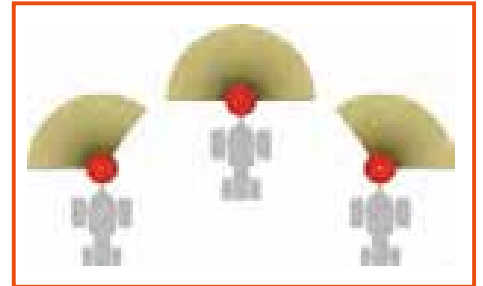

Adjustable spread pattern



POLY-HOP			
203-220	206-221	209-421	212-421
16-30	16-30	20-50	20-50
81	102	125	136
116	145	160	171
3.71 / 237	5.30 / 339	8.58 / 549	11.95 / 765
23'	23'	46'	46'
32"	35"	42"	48"
31"	34"	40"	46"
ASAE cat. 1	ASAE cat. 1	ASAE cat. 1	ASAE cat. 1
\$ 831	\$ 1,021	\$ 1,309	\$ 1,365

STANDARD

Stainless steel adjustable spreader wings on 209 & 212 models



Stainless steel hopper bottom plate



Stainless steel gates opening control on 206, 209 & 212 models









NOTE: Poundage capacity calculated @ 13-13-13 fertilizers weight of 64 lbs per cu. ft.
All Hop fertilizers are priced at 2 per pallet. Add \$25 net for single units orders.

TURBO-HOP 301 / 30320-60 HP (15-45 KW)
540 rpm - cat. 1 & 2**Pendular spreaders**

- Sturdy tubular frame.
- Heavy duty cast iron gearbox in oil bath.
- Accurate flow control adjustment.
- Ideal for the distribution of fertilizer, seed, salt and sand where accuracy and precision in application are needed.
- Full spread or left / right discharge pattern.
- Polyethylene hopper.
- Spreader spouts made of nylon and reinforced fiberglass.
- Stainless steel opening control disc.
- Cast iron anti-wear agitator.
- 3 point linkage, cat. 1 on model 301 and cat. 1&2 on model 303.
- Heavy duty shielded PTO shaft (1 3/8" ASAE cat. 1) with shock absorber and shear bolt safety.
- Safety shields standard.



MODEL		301-300	301-400	303-600	303-800	303-999
 HP		20-60	20-60	20-60	20-60	20-60
 lbs		256	267	419	448	455
 mph		2 to 10	2 to 10	2 to 10	2 to 10	2 to 10
 cu.ft/lbs		9.00 / 576	12.80 / 820	20.6 / 1,318	30.3 / 1,939	36.1 / 2,310
 ft		17'-65'	17'-65'	17'-65'	17'-65'	17'-65'
 in		44"	48"	38"	43"	47"
 1 3/8"	ASAE cat. 1 shear bolt	ASAE cat. 1 shear bolt	ASAE cat. 1 shear bolt	ASAE cat. 1 shear bolt	ASAE cat. 1 shear bolt	ASAE cat. 1 shear bolt
\$		\$ 2,940	\$ 3,204	\$ 3,931	\$ 4,319	\$ 4,715

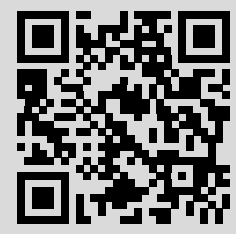
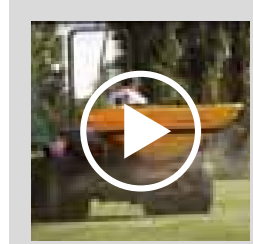

NOTE: Poundage capacity calculated @ 13-13-13 fertilizers weight of 64 lbs per cu. ft.



Adjustable spread pattern

STANDARD



Corrosion resistant polyethylene hopper



Heavy duty gearbox in oil bath manufactured by Befco

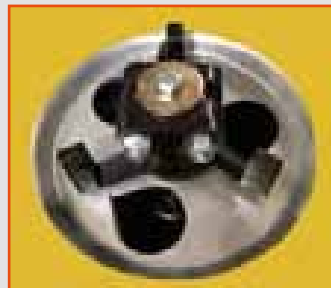

Distributing unit in stainless steel and agitator in stamped steel



Graded scale for accurate flow control adjustment

CORE AERATOR SD

20-50 HP (15-37 KW)
cat. 1



Standard duty core aerators

- Hub spacing 6 1/2".
- Special high tensile steel shafts on the rotors.
- 2 bronze bushings per rotor.
- 8 gauge formed steel support panels.
- All panels support rotors from all sides.
- 1 1/4" rotor support shaft.
- 3/8" formed Cat. 1 "A" frame.
- Machine equipped with spikes instead of spoons is available on request.
- 3 point linkage, Cat. 1.
- 6 spoons per hub.
- All flanges are welded to rotors.
- Flange thickness 3/16".
- 3 support stands.
- 3/4" hardened steel spoons.
- Front or rear tractor mounting.

MODEL	BCA-048	BCA-060	BCA-072
HP	20-50	20-50	20-50
in	48"	60"	72"
in	54"	65"	78"
lbs	284	357	401
N°	4	5	6
N°	8	10	12
N°	48	60	72
in	4 1/2"	4 1/2"	4 1/2"
in	12" x 15"	19" x 15"	25" x 15"
lbs	78 ea.	125 ea.	160 ea.
	\$ 2,278	\$ 2,389	\$ 2,581

STANDARD

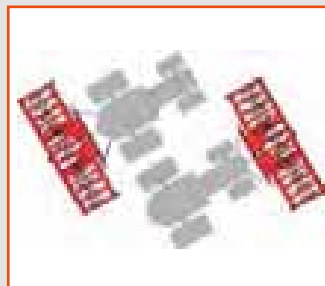

Front or rear tractor mounting



Both hub flanges are welded and equipped with two bronze bushings per rotor

CORE AERATOR HD

20-70 HP (15-52 KW)
cat. 1 & 2



Heavy duty core aerators

- Hub spacing 6 1/2".
- Special high tensile steel shafts on the rotors.
- 2 bronze bushings per rotor.
- 3/16" formed steel support panels.
- All panels support rotors from all sides.

- 1 1/4" rotor support shaft.
- 3/8" formed Cat. 1 & 2 "A" frame.
- Machine equipped with spikes instead of spoons is available on request.
- 3 point linkage, Cat. 1 & 2.
- 8 spoons per hub.
- All flanges are welded to rotors.
- Flange thickness 3/16".
- 3/4" hardened steel spoons.
- Front or rear tractor mounting.
- 3 support stands.

STANDARD



Eight spoons per flange



Choice of hollow spoons or solid spikes

MODEL		BCA-260	BCA-272
	HP	20-70	20-70
	in	60"	72"
	in	65"	78"
	lbs	444	549
	N°	5	6
	N°	10	12
	N°	80	96
	in	4 1/2"	4 1/2"
	in	19" x 21"	25" x 21"
	lbs	170 ea.	220 ea.
		\$ 3,032	\$ 3,355

SOIL PULVERIZERS SD

25-50 HP (19-37 KW)
cat. 1



Standard duty soil pulverizers

- 3/8" steel spikes fully welded in a timed scroll pattern on a heavy walled roller with two 160 lbs compression springs.
- Optional 2nd spiked roller available with two 80 lbs compression springs.
- 10" (49.1 lb/ft) frame beam.
- Reversible heat treated 1/2" x 2" shanks.
- 3 point linkage, cat. 1.
- 5 9/16" diameter spiked roller tube.
- Self aligning 1" bearings on roller.
- Formed plate "A" frame.

MODEL		BPL-048	BPL-060	BPL-072
	HP	25-50	25-50	25-50
	in	48"	60"	72"
	lbs	496	652	679
	lbs	544	702	729
	N°	17	21	25
	N°	70	88	106
	in	2 13/16"	2 13/16"	2 13/16"
	in	4 1/2"	4 1/2"	4 1/2"
	lbs	160 lbs per spring	160 lbs per spring	160 lbs per spring
		\$ 1,949	\$ 2,084	\$ 2,297

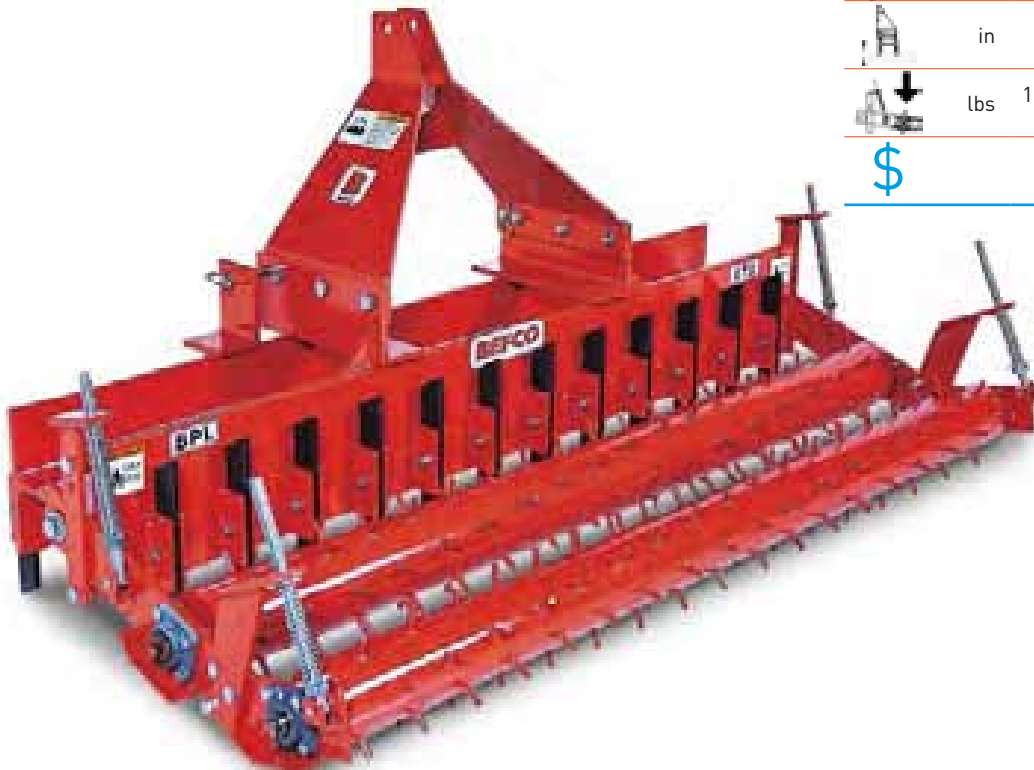

SOIL PULVERIZERS HD

40-90 HP (30-67 KW)
cat. 1



Heavy duty soil pulverizers

- 3/8" steel spikes fully welded in a timed scroll pattern on a heavy walled roller with two 160 lbs compression springs.
- Optional 2nd spiked roller available with two 80 lbs compression springs.
- 12" (59.4 lb/ft) frame beam.
- Reversible heat treated 1/2" x 2" shanks.
- 3 point linkage, cat. 1.
- 6 5/8" diameter spiked roller tube.
- Self aligning 1" bearings on roller.
- Formed plate "A" frame.

MODEL		BPL-272	BPL-284
	HP	40-90	40-90
	in	72"	84"
	lbs	781	875
	lbs	846	940
	N°	25	29
	N°	106	124
	in	2 13/16"	2 13/16"
	in	4 1/2"	4 1/2"
	lbs	160 lbs per spring	160 lbs per spring
		\$ 2,751	\$ 3,111

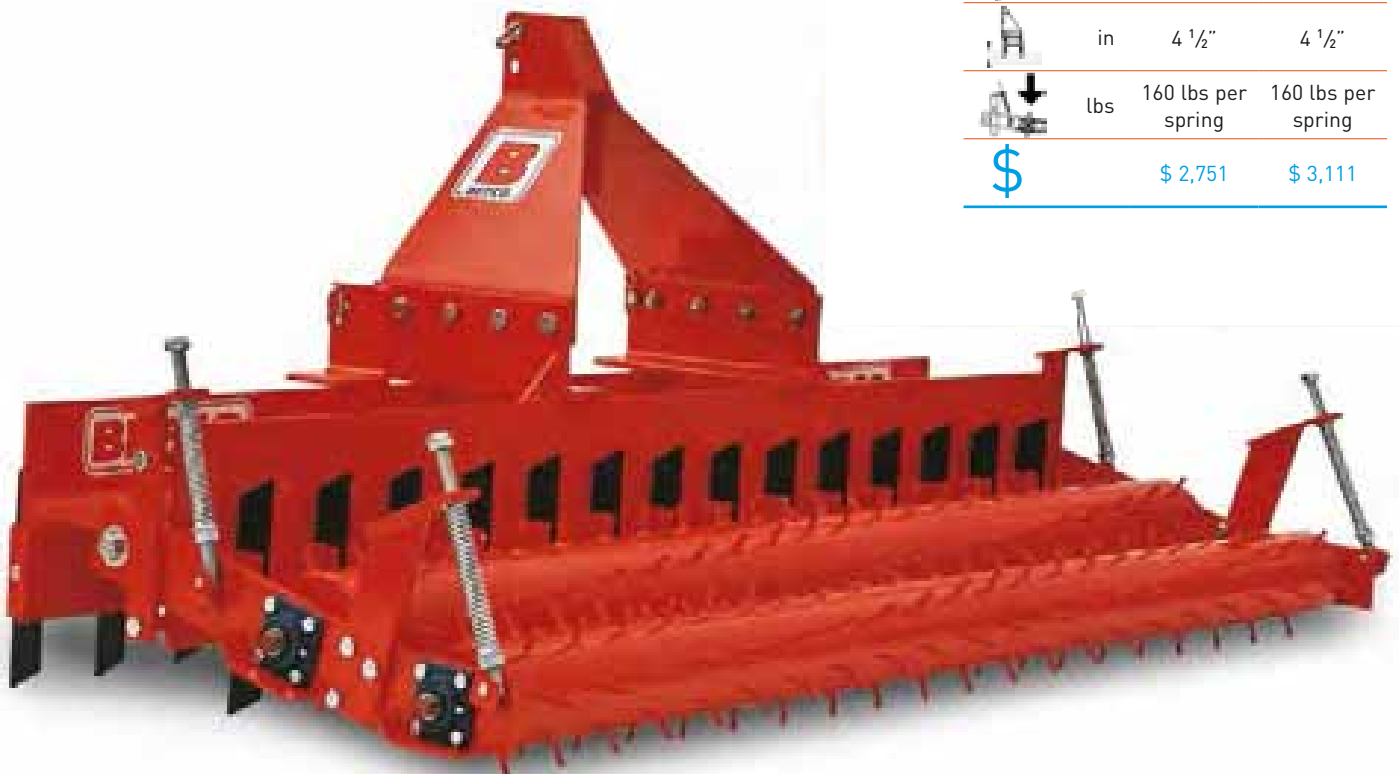

BOX SCRAPER

16-65 HP (12-48 KW)
cat. 1



- Roll formed moldboard.
- 3 point linkage, cat. 1.
- 2 bolt-on 1/2" x 6" heat treated blades with reversible cutting edge.
- Hardened steel ripping shanks with replaceable tips.
- Reinforced box design.

MODEL	BBS-C48	BBS-060	BBS-072	BBS-084
	SUBCOMPACT SERIES		STANDARD DUTY SERIES	
HP	16-30	25-65	25-65	25-65
in	48"	60"	72"	84"
lbs	251	470	530	630
lbs	276	505	570	680
N°	4	5	6	7
\$	\$ 829	\$ 1,252	\$ 1,390	\$ 1,643

Standard duty series



Subcompact series

GRADING SCRAPER

16-65 HP (12-48 KW)
cat. 1

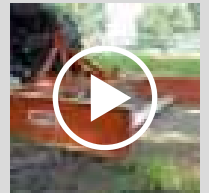

MODEL		BGS-C48	BGS-060	BGS-072	BGS-084
		SUBCOMPACT SERIES	STANDARD DUTY SERIES		
	HP	16-30	25-65	25-65	25-65
	in	48"	60"	72"	84"
	in	52"	64"	76"	89"
	lbs	350	592	703	764
	lbs	386	628	739	800
	N°	-	5	6	7
	in	10 3/4"	12 1/2"	12 1/2"	12 1/2"
	in	0"-1 1/2"	0"-1 1/2"	0"-1 1/2"	0"-1 1/2"
		1,116	1,429	1,580	1,834

- 3 point linkage, cat. 1.
- Adjustable height grading blades.
- Adjustable hardened steel ripping shanks with replaceable tips, on standard duty series.
- Heavy duty frame.
- 2 reversible and replaceable bolt-on 1/2" x 6" heat treated high carbon steel blades.
- Replaceable full length skid shoes.

STANDARD

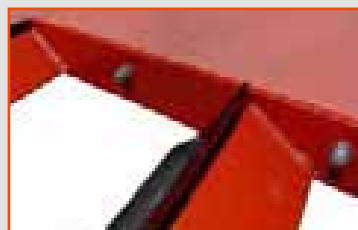

Adjustable height grading blades



Skid shoes

REAR BLADE SD

16-50 HP (12-37 KW)
cat. 1

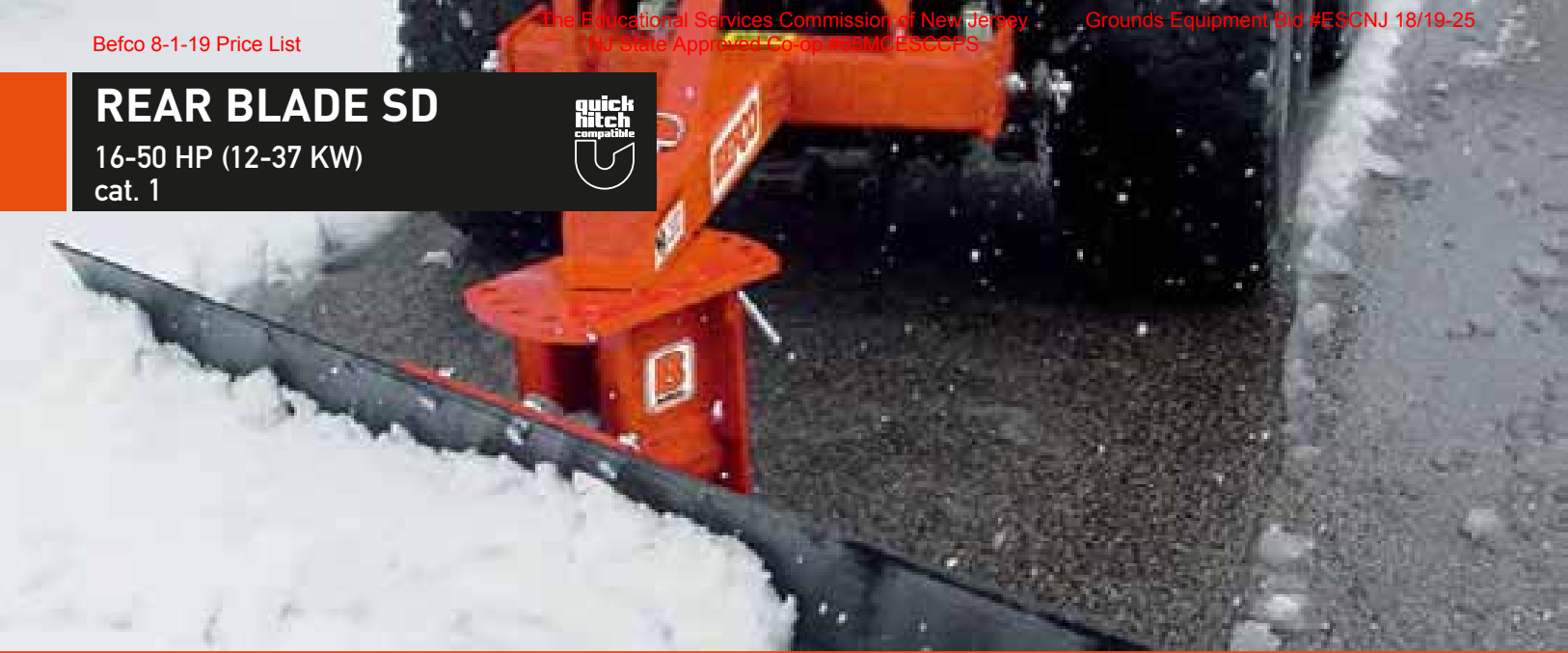

Standard duty rear blades

- 5 forward & 5 reverse positions on standard duty series.
- 3 forward and 3 reverse positions on subcompact series.
- Sturdy frame construction.
- Left or right offset.
- 3 tilt positions on standard duty series.
- 1/2" x 6" heat treated reversible cutting blade.
- 1/4" moldboard thickness.
- 3 point linkage, cat. 1.

MODEL		BRB-C48	BRB-C60	BRB-072	BRB-084
		SUBCOMPACT SERIES		STANDARD DUTY SERIES	
	HP	16-30	16-30	25-50	25-50
	in	48"	60"	72"	84"
	lbs	139	158	275	294
	lbs	189	208	325	344
		-	-	14°	14°
		16°	16°	16° & 32°	16° & 32°
	in	6"	6" or 12"	6" or 12"	6" or 12"
	\$	\$ 715	\$ 742	\$ 1,025	\$ 1,062

All subcompact and standard duty blades are crated 2 each of the same model. Add \$50 net for single order units.

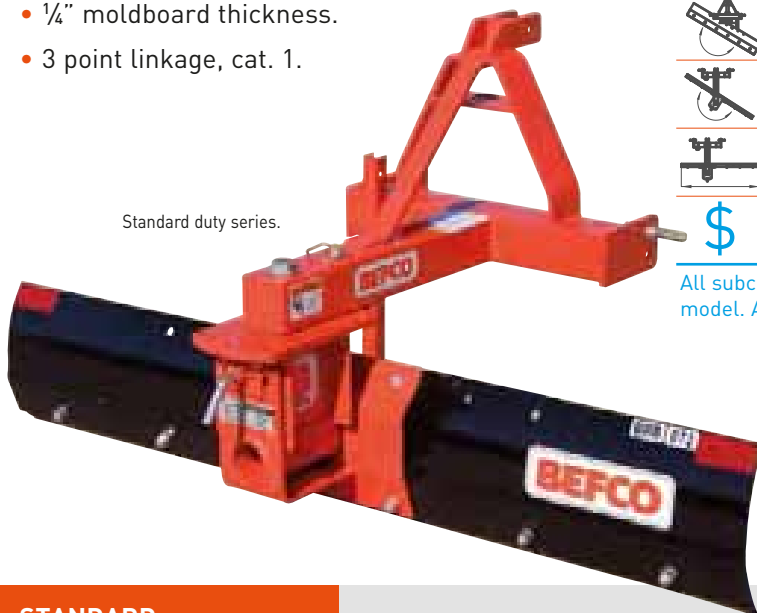

STANDARD

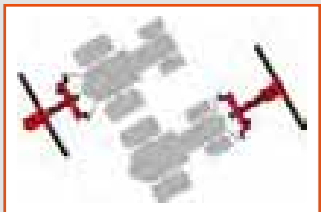

Front or rear tractor mounting

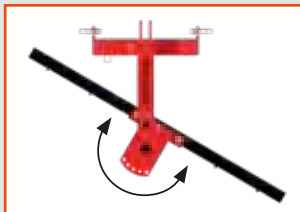

Up to 32° angling on standard duty blades

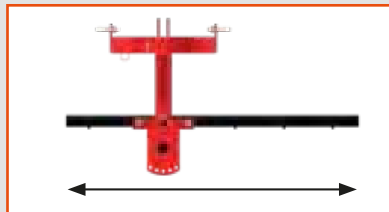

Up to 12" offset

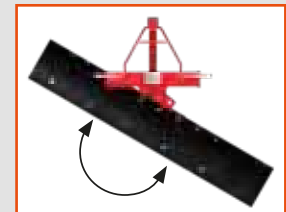

Up to 14° tilt on standard duty blades

REAR BLADE HD

30-80 HP (22-60 KW)
cat. 1 & 2



Heavy duty rear blades

- 16 forward & 16 reverse positions.
- Right or left offset.
- 5 tilt positions.
- 3 point linkage, cat. 1 & 2.
- 1/2" x 6" heat treated reversible cutting blade.
- 1/4" moldboard thickness.
- Reinforced moldboard for increased strength.



MODEL	BRB-284	BRB-296
HP	30-80	30-80
in	84"	96"
lbs	524	561
lbs	602	644
	15° & 30°	15° & 30°
	up to 60°	up to 60°
in	up to 21"	up to 21"
\$	\$ 1,940	\$ 2,086

STANDARD

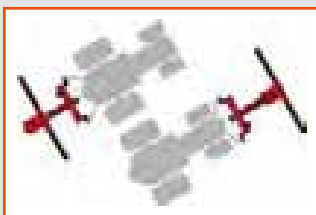

Front or rear tractor mounting

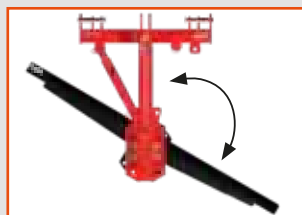

Up to 60° angling

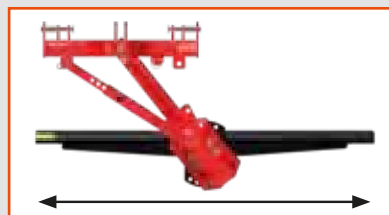

Up to 12" offset

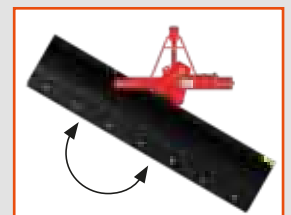

Up to 30° tilt

LANDSCAPE RAKE

16-65 HP (12-48 KW)
cat. 1



- 5 forward & 5 reverse positions on standard duty series.
- 3 forward and 3 reverse on subcompact series.
- Sturdy frame construction.
- 2" center tine spacing.
- 2 hole tine 5/16" x 1" on standard duty series.
- 1 hole tine 5/16" x 1" on subcompact series.
- 3 point linkage, cat. 1.



Subcompact series

Standard duty series

STANDARD

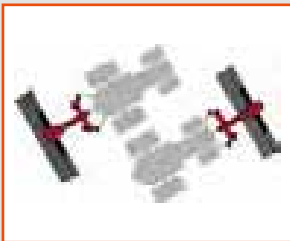

Front or rear tractor mounting



Up to 32° angling on standard duty rakes

	MODEL	BLR-C48	BLR-C60	BLR-072	BLR-084	BLR-096
		SUBCOMPACT SERIES		STANDARD DUTY SERIES		
	HP	16-30	16-30	25-65	25-65	25-65
	in	48"	60"	72"	84"	96"
	lbs	135	156	248	274	314
	lbs	180	198	293	319	359
		16°	16°	16° & 32°	16° & 32°	16° & 32°
	N°	24	30	36	42	48
		\$ 711	\$ 817	\$ 1,053	\$ 1,186	\$ 1,320

All subcompact and standard duty rakes are crated 2 each of the same model. Add \$50 net for single order units.

SICKLE BAR MOWERS

20-75 HP (15-56 KW)
540 rpm - cat. 1 & 2



- 3 point linkage, cat. 1 & 2.
- Double action sickle bar.
- Single action hydraulic cylinder with restrictor.
- Safety release standard on all units.
- Transport lock bar secures cutting bar for transport and storage.
- Transport blade guard standard.
- Equipped with cylinder stop to raise cutting bar using tractor's hydraulic system.
- Ideal for set-aside, conservation acreage and ditchbank mowing.
- Delivered with extra cutting blade.
- Will mow 90° up and 55° down.
- Heavy duty shielded pto shaft (1 3/8" ASAE cat. 4).



BSB-284

STANDARD



Spring loaded blade guides for quick and easy blade replacement

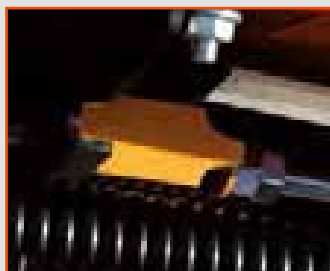

Easy to inspect and adjust belt tensioner

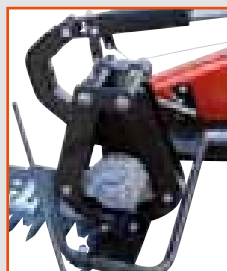

Cast aluminium connecting rods with cooling fins

MODEL	BSB-272	BSB-284	BSB-296
HP	20-75	20-75	20-75
in	72"	84"	96"
in	130"	142"	154"
lbs	628	650	672
lbs	717	750	782
mph	9	9	9
	Hydraulic	Hydraulic	Hydraulic
1 3/8"	ASAE cat. 4	ASAE cat. 4	ASAE cat. 4
	\$ 6,265	\$ 6,459	\$ 7,158



FINGER WHEEL RAKES

16-80 HP (12-60 KW)
cat. 1

RS2-04V

- 3 point linkage, cat. 1.
- Cast steel hubs with greasable tapered bearings.
- Quick hitch compatible on models RS2-02R, RS2-03R, RS2-04V & RS2-06V
- Finger wheel rakes may also be used for spreading (2, 3, 4 & 6 wheel models only) or turning hay (RS2-04R & RS2-06R models only).
- Lifts hay gently, even from undulating terrain.
- Bent elbows allow better hay flow under heavy working conditions.

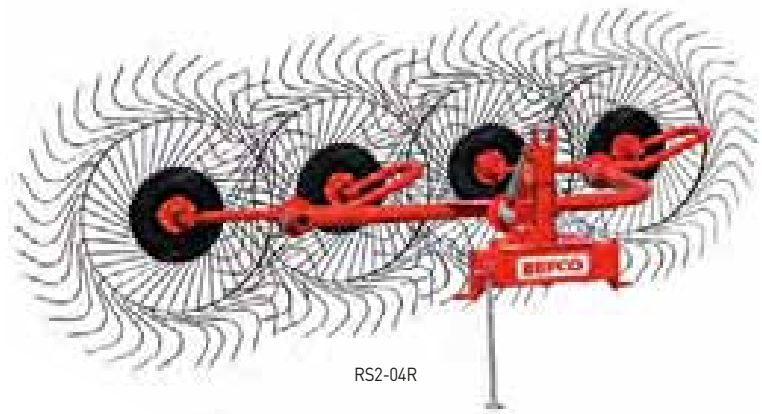

RS2-04R

STANDARD

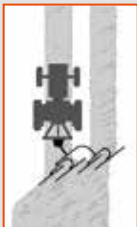
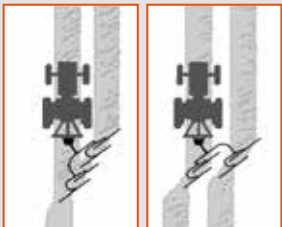

Rakes can be used for raking, turning and spreading



Cast steel hubs with greasable tapered bearings

MODEL		RS2-02R	RS2-03R	RS2-04R	RS2-05R	RS2-06R	RS2-04V	RS2-06V
	HP	16-30	16-30	30-80	30-80	30-80	16-30	16-30
	N°	2	3	4	5	6	4	6
	Ø in	56"	56"	56"	56"	56"	56"	56"
	N°	40	40	40	40	40	40	40
	Ø in	3/32"	3/32"	3/32"	3/32"	3/32"	3/32"	3/32"
	ft	4'3"	6'5"	8'6"	11'	12'9"	11'6"	15'10"
	ft	7'4"	8'4"	4'9"	7'5"	7'5"	10'2"	12'7"
	ft	7'6"	10'	12'10"	14'6"	17'3"	7'6"	10'
	mph	14	14	14	14	14	14	14
	lbs	194	291	388	495	602	353	547
		\$ 736	\$ 1,085	\$ 1,454	\$ 1,777	\$ 2,123	\$ 1,360	\$ 2,011

NOTE: For left hand models order with "L" suffix. (ie. RS2-04L)



HRC-08V

FINGER WHEEL "V" RAKES

16-80 HP (12-60 KW)

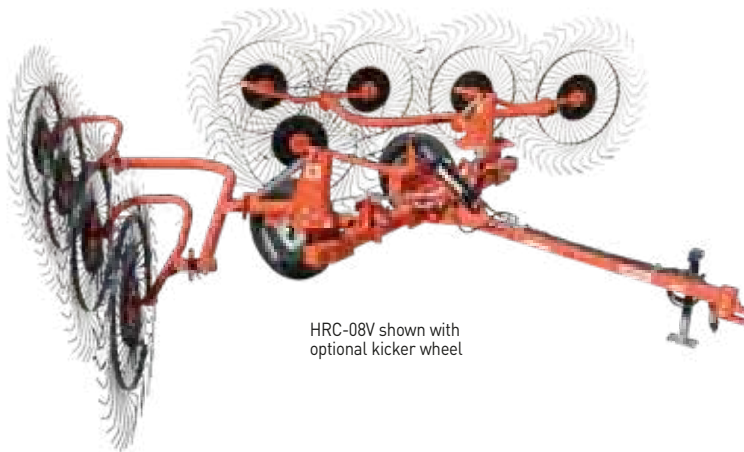

HRC-08V shown with optional kicker wheel

HRC-08V	HRC-10V	HRC-12V
30-80	30-80	30-80
8	10	12
56"	56"	56"
40	40	40
3/32"	3/32"	3/32"
21'4"	23'4"	25'7"
8'	8'	8'
8'10"	10'	12'1"
14	14	14
1,290	1,457	1,623
\$ 5,791	\$ 6,437	\$ 7,129

- Working speed of up to 14 mph, low costs of maintenance, and ease of use make these units indispensable for raking hay.
- Floating rake wheels with spring steel tines follow ground contour evenly.
- Multiple adjustment capabilities allow operator to adjust raking width, windrow width and raking angle.
- Pull type 8, 10 and 12 wheel rakes with double action hydraulic cylinders for easy transportation and storage.
- Hydraulic ball valves allow for single side operation and lock rakes during transport and storage.
- Narrow 8' transport width allows rakes to be easily transported to different work locations.
- 8 and 12 wheel rakes may be adjusted to spread or turn crop.
- Optional center kicker wheel with additional hydraulic cylinder.

STANDARD

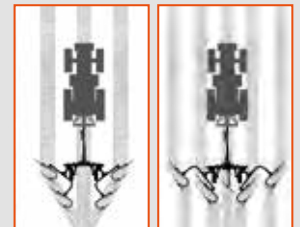

"V" rakes can be used for raking, turning and spreading



Two hydraulic cylinders with ball valves



Narrow 8" transport width



Springs adjust the pressure of the wheels to the ground

TEDDERS

20-60 HP (15-45 KW)
540 rpm



- Heavy frame construction.
- High strength steel tine arms.
- Large diameter 15" x 6" pneumatic tires.
- Easy pull type hook up.
- Heavy duty shielded PTO shaft with ratchet torque limiter.
- Spring steel double hay tines.
- Sturdy guard rail for added safety.



MODEL	DRP-330	DRP-480
HP	20-50	30-60
ft	11'	16'
lbs	457	738
N°	2	4
N°	6	6
1 3/8"	ASAE cat. 2 ratchet torque limiter	ASAE cat. 4 ratchet torque limiter
\$	\$ 3,498	\$ 6,973

All DRP-330 are crated 2 each. Add \$50 net for single order units.

STANDARD

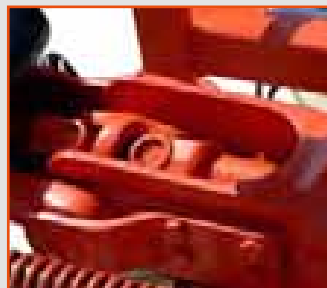

DRP-480 double yoke joint transmission



DRP-480 in transport position



WINDROWER RAKES

20-50 HP (15-37 KW)
 540 rpm - cat. 1 & 2









STANDARD



Heavy duty gearbox with raking depth adjustment handle







- Heavy frame construction.
- Heavy duty shielded PTO shaft (1 3/8" ASAE cat. 1) with ratchet torque limiter.
- Tubular steel tine arms.
- Large diameter pneumatic tires.
- Spring steel double hay tines.
- Easy tine arm removal system.
- Sturdy guard rail for added safety.
- Angled tines for high clearance.
- 3 point linkage, cat. 1 & 2.

MODEL	DR0-308	
	HP	20-50
	ft	10'
	lbs	650
	N°	8
	N°	3
	1 3/8"	ASAE cat. 1 ratchet torque limiter
		\$ 5,185

QUICK HITCH



- ASABE cat. 1 Quick Hitch.
- Works with all BEFCO cat. 1 Quick Hitch compatible implements.
- Look for the  symbol throughout the catalog for compatible implements.
- Optional floating Quick Hitch Adapter for C30, C50 & C70 grooming mowers. Adapter allows mowers to maintain its full float capability while using Quick Hitch.
- Optional Quick Hitch adapter available for Hop 203 fertilizer spreader.

MODEL	QH1-100	
		Cat. 1
	in	30 1/2"
	in	22"
	in	8"
	lbs	57
		\$ 493

OPTIONALS



OPTIONALS CYCLONE C30-CE5

005-600

• Mulching kit

\$ 374

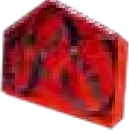

OPTIONALS CYCLONE C30

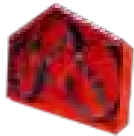

• Mulching kit

004-600 C30-RD4 **\$ 322**

005-600 C30-RD5 **\$ 374**

006-600 C30-RD6 **\$ 400**



001-600

• Front antiscalping roller

\$ 124

001-700

• Quick hitch adapter

\$ 442



OPTIONALS CYCLONE C50

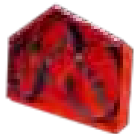

• Mulching kit

005-700 C50-RD5 **\$ 386**

006-700 C50-RD6 **\$ 440**

007-700 C50-RD7 **\$ 514**

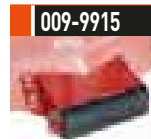

009-9915

• Front antiscalping roller
 (standard on C50-RD7 model)

\$ 141



• Rear roller kit

009-9941 C50-RD5 **\$ 796**

009-9942 C50-RD6 **\$ 823**

009-9943 C50-RD7 **\$ 846**

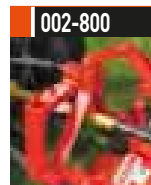

002-800

• Quick hitch adapter

\$ 414

OPTIONALS CYCLONE C70

002-800

• Quick hitch adapter

\$ 414



OPTIONALS CYCLONE FLEX

009-9817

• Hydraulic unlocking system

\$ 593

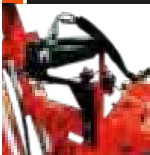

• Mulching kit

009-9556

312-FLX

\$ 1,106

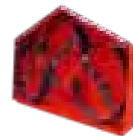

009-9557

315-FLX

\$ 1,212

009-9558

317-FLX

\$ 1,320

009-9597

• Floating hitch, additional

\$ 273



009-9599

• Roadway kit

\$ 482

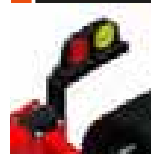

• Rear roller kit

009-9945

312-FLX

\$ 2,338



009-9946

315-FLX

\$ 2,415

009-9947

317-FLX

\$ 2,469

OPTIONALS CYCLONE SUPER FLEX

009-9817

• Hydraulic unlocking system

\$ 593

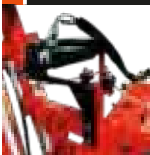

• Mulching kit

009-9556

412-SFL

\$ 1,106



009-9557

415-SFL

\$ 1,212

009-9558

417-SFL

\$ 1,320

009-9559

420-SFL

\$ 1,542

009-9597

• Front floating hitch, additional

\$ 273

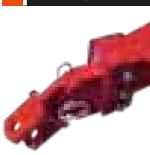

009-9599

• Roadway kit

\$ 482

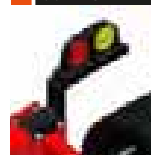



• Rear roller kit

009-9950	412-SFL	\$ 2,400
009-9951	415-SFL	\$ 2,475
009-9952	417-SFL	\$ 2,525
009-9953	420-SFL	\$ 2,601

OPTIONALS HURRICANE H40

009-9507

• Side skids

\$ 115



009-9560

• Overrunning clutch for driveline

\$ 149



• Rotor with dethatching blades (factory installed)

DBD48H40	H40-048	net \$ 319
DBD60H40	H40-060	net \$ 358
DBD72H40	H40-072	net \$ 387



• Rotor with reverse "Y" blades (factory installed)

YBD48H40	H40-048	net \$ 200
YBD60H40	H40-060	net \$ 200
YBD72H40	H40-072	net \$ 200



• Rotor with triangular paddle blades (factory installed)

TBD48H40	H40-048	net \$ 200
TBD60H40	H40-060	net \$ 200
TBD72H40	H40-072	net \$ 200



• Rotor with hammers (factory installed)

HBD48H40	H40-048	net \$ 325
HBD60H40	H40-060	net \$ 414
HBD72H40	H40-072	net \$ 486

OPTIONALS HURRICANE H40-S

009-9206

• Side skids

\$ 135



009-9560

• Overrunning clutch for driveline

\$ 149



• Rotor with dethatching blades (factory installed)

DBD48H40	H40-S48	net \$ 319
DBD60H40	H40-S60	net \$ 358
DBD72H40	H40-S72	net \$ 387



• Rotor with reverse "Y" blades (factory installed)

YBD48H40	H40-S48	net \$ 200
YBD60H40	H40-S60	net \$ 200
YBD72H40	H40-S72	net \$ 200



• Rotor with triangular paddle blades (factory installed)

TBD48H40	H40-S48	net \$ 200
TBD60H40	H40-S60	net \$ 200
TBD72H40	H40-S72	net \$ 200



• Rotor with hammers (factory installed)

HBD48H40	H40-S48	net \$ 325
HBD60H40	H40-S60	net \$ 414
HBD72H40	H40-S72	net \$ 486

009-9207 • Hydraulic cylinder for side shift **\$ 438**



• Front steel deflectors

009-9208	H40-S48	\$ 165
009-9209	H40-S60	\$ 198
009-9210	H40-S72	\$ 240



RVRXXH40 • Reverse rotation (factory installed) **net \$ 300**



OPTIONALS HURRICANE H70

009-9691 • Gauge wheels with laminated tires H70 **\$ 1,038**



009-9701 • Gauge wheels with laminated tires H80 **\$ 1,231**



• Rotor with dethatching blades (factory installed)

DBD60H70	H70-060	net \$ 358
DBD72H70	H70-072	net \$ 397
DBD88H70	H70-088	net \$ 437



• Rotor with reverse "Y" blades (factory installed)

YBD60H70	H70-060	net \$ 200
YBD72H70	H70-072	net \$ 200
YBD88H70	H70-088	net \$ 200



• Rotor with triangular paddle blades (factory installed)

TBD60H70	H70-060	net \$ 200
TBD72H70	H70-072	net \$ 200
TBD88H70	H70-088	net \$ 200



• Rotor with hammers (factory installed)

HBD60H70	H70-060	net \$ 414
HBD72H70	H70-072	net \$ 499
HBD88H70	H70-088	net \$ 586



RVRXXH70 • Reverse rotation (factory installed) **net \$ 300**



OPTIONALS DESTROYER D90

GDTXXD90 • Gearbox with dual PTO (factory installed) **net \$ 269**



009-9969 • Side skirts **\$ 241**



OPTIONALS
BM6-2HR

BM6-000 • 15" blower pipe extension **\$ 160**



OPTIONALS
TORNADO BRC

009-9986 • Side skids **\$ 43**



OPTIONALS
TILL-RITE T30

RVRXXT30 • Reverse rotation (factory installed) **net \$ 300**



OPTIONALS
TILL-RITE T40



• Aerator rotor

009-9852	T40-150, T40-250	\$ 1,081
009-9853	T40-158, T40-258	\$ 1,267
009-9854	T40-166, T40-266	\$ 1,471

RVRXXT40 • Reverse rotation **net \$ 300**



OPTIONALS TILL-RITE T50

RVRXT50 • Reverse rotation (factory installed) **net \$ 300**



OPTIONALS TILL-RITE T60

RVRXT60 • Reverse rotation (factory installed) **net \$ 300**



OPTIONALS TILL-RITE T70

RVRXT70 • Reverse rotation (factory installed) **net \$ 300**



OPTIONALS GREEN-RITE GRT

009-9875 • Gauge wheels for all models **\$ 418**



009-9648 • Front roller **GRT-250 \$ 663**

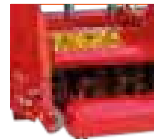

009-9516 GRT-258 **\$ 700**

009-9563 GRT-266 **\$ 758**

009-9566 GRT-282 **\$ 818**

Note: units may utilize gauge wheels or front roller for depth control, but not both

009-9649 • Tiller rotor **GRT-250 \$ 655**



009-9517 GRT-258 **\$ 740**

009-9564 GRT-266 **\$ 823**

009-9567 GRT-282 **\$ 1,531**

009-9650 • Rear roller scraper **GRT-250 \$ 229**



009-9539 GRT-258 **\$ 262**

009-9565 GRT-266 **\$ 365**

009-9568 GRT-282 **\$ 416**



• Cast iron roller rings (factory installed)

CSR50GRT	GRT-250	net \$ 477
CSR58GRT	GRT-258	net \$ 529
CSR66GRT	GRT-266	net \$ 581
CSR82GRT	GRT-282	net \$ 704

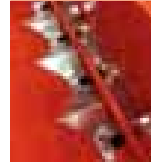

• Seed conveyor kit

009-9139	GRT-250	\$ 96
009-9140	GRT-258	\$ 112
009-9141	GRT-266	\$ 126
009-9142	GRT-282	\$ 157

OPTIONALS SEED-RITE SRT

CSR74SRT

• Cast iron roller rings (factory installed)

net \$ 1,455



009-9985

• Seed rate speed reduction kit

\$ 83



009-9138

• Seed conveyor kit

\$ 142



009-9930

• Rear expanded roller frame for seed covering/dethatching with adjustable tickler tines

\$ 599



OPTIONALS MOLE 200 / 300

009-9851

• Hook-up stand all models

\$ 441



009-9154

• Hydraulic down force kit 200-512

\$ 663



009-9155

• Hydraulic down force kit 300-512 & 400-512 model

\$ 680

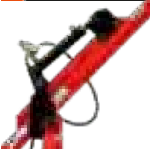

PHD-003

• Auger positioning handle all models

\$ 161



OPTIONALS BABY-HOP POLY BABY-HOP

AA1-120

• Deflector shield

\$ 101



009-9856

• Remote gate control

\$ 359





	• Hopper cover	009-9720	for all 103 models	\$ 219
		009-9721	for all 106 models	\$ 228

OPTIONALS HOP POLY-HOP

009-9979	• Tumbling style agitator for all 203 models	\$ 85
		

009-9978	• Tumbling style agitator for all 206, 209 & 212 models	\$ 85
		

009-9458	• Side row discharge for all 209 & 212 models	\$ 429
		

009-9524	• Deflector shield for all 203 & 206 models	\$ 100
		

009-9638	• Deflector shield for all 209 & 212 models	\$ 195
		

009-9856	• Remote gate control for all 203 models	\$ 359
		

009-9850	• Remote gate control for all 206, 209 & 212 models	\$ 359
		

009-9913	• Filter grate for all 209 & 212 models	\$ 490
		

	• Hopper cover	009-9720	for all 203 models	\$ 219
		009-9721	for all 206 models	\$ 228
		009-9722	for all 209 models	\$ 245
		009-9723	for all 212 models	\$ 252

009-9239	• Quick hitch adapter for all 203 models	\$ 45
		



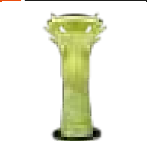





OPTIONALS TURBO-HOP 301

009-9452	• Short spout for sand and salt	\$ 329
		

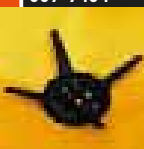
009-9451	• Rubber insert for damp material	\$ 118
		

009-9453	• Agitator extension	\$ 196	009-5370	• Left only & right only directional attachment	\$ 80
					
001-4984	• Locking nut for spout	\$ 50	009-9913	• Filter grate	\$ 490
					
009-9456	• Hydraulic control	\$ 714	• Hopper cover	009-9722 301-300	\$ 245
				009-9723 301-400	\$ 252

OPTIONALS TURBO-HOP 303

009-9452	• Short spout for sand and salt	\$ 329	009-9451	• Rubber insert for damp material	\$ 118
					
009-9454	• Agitator extension	\$ 196	009-5370	• Left only & right only directional attachment	\$ 80
					
001-4984	• Locking nut for spout	\$ 50	009-5410	• Filter grate	\$ 465
					
009-9457	• Hydraulic control	\$ 714	• Hopper cover	009-9725 303-600	\$ 278
				009-9726 303-800	\$ 285
				009-9727 303-999	\$ 298

OPTIONALS CORE AERATOR SD



- Steel weight sand tank, price per unit

009-9731	BCA-048	\$ 298
009-9732	BCA-060	\$ 311
009-9733	BCA-072	\$ 325



- Unit with spikes instead of spoons (factory installed)

SPO48BCA	BCA-048	net \$ 255
SPO60BCA	BCA-060	net \$ 367
SPO72BCA	BCA-072	net \$ 482

FRTSDBC

- Front mounted (factory installed)

net \$ 200



OPTIONALS CORE AERATOR HD



- Steel weight sand tank, price per unit

009-9734	BCA-260	\$ 350
009-9735	BCA-272	\$ 377



- Unit with spikes instead of spoons, (factory installed)

SP260BCA	BCA-260	net \$ 556
SP272BCA	BCA-272	net \$ 708

FRTHDBC

- Front mounted (factory installed)

net \$ 200



OPTIONALS SOIL PULVERIZERS SD

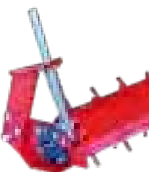

- 2nd rear roller assembly Ø 5"

009-9887	BPL-048	\$ 535
009-9636	BPL-060	\$ 622
009-9637	BPL-072	\$ 758

OPTIONALS SOIL PULVERIZERS HD

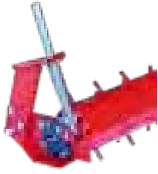

• 2nd rear roller assembly Ø 5 7/16"

009-9646 BPL-272 \$ 885

009-9647 BPL-284 \$ 953

OPTIONALS REAR BLADE SD

BRB-001

• Skid shoes

\$ 83



OPTIONALS REAR BLADE HD

BRB-001

• Skid shoes

\$ 83



BRB-002

• Hydraulic offset control

\$ 335



OPTIONALS LANDSCAPE RAKE BLR

BLR-001

• Gauge wheels (standard duty series)

\$ 470



BLR-002

• Gauge wheels (subcompact series)

\$ 427



OPTIONALS FINGER WHEEL "V" RAKES

009-9982

• Kicker wheel for HRC models
 (includes hydraulic cylinder)

\$ 618



OPTIONALS TEDDERS

009-9966

• Hydraulic lift kit for model DRP-480

\$ 1,133



**USE ONLY
 BEFCO ORIGINAL SPARE PARTS**

FOR YOUR REFERENCE:

Dealer Account number

Rep name

Rep telephone

Sales telephone

(800) 334-6617

Sales fax

(252) 977-9718

Sales e-mail

sales@befco.com

Parts telephone

(877) 663-3458

Parts fax

(800) 265-6962

Parts e-mail

parts@befco.com

LIMITED WARRANTY

BEFCO's responsibility will be limited to the substitution of the acknowledged defective merchandise to the same place of delivery as the previous one was supplied.

1. LIMITED WARRANTY

BEFCO, Inc. herein referred to as the Company, warrants its machines and related accessories, hereafter referred to as the Machine, to be free from defects in material and workmanship, for a period of twelve (12) months from the date of invoice to the first registered owner; **this limited warranty does not apply to and excludes shear bolt and/or slip clutch, oil, grease, tires, tubes, hydraulic hoses, knives, blades, augers, and PTO shafts.** Labor will be reimbursed at \$40.00 per hour based on BEFCO's time schedule.

Cost of transport to the servicing dealer is the responsibility of the customer.

Warranty coverage shall not be transferable from the first owner to any subsequent owner.

2. DISCLAIMER OF ALL OTHER WARRANTIES AND REMEDIES

Neither the Company nor any company affiliated with the Company makes any warranties, expressed or implied, as to the quality, performance or application of its products other than those set forth herein and does not make any implied warranty of merchantability or fitness. The only remedies the purchaser has in connection with the breach, or performance of any warranty on the Company's Machine are those set forth herein. In no event will the dealer, the Company, or any company affiliated with the Company be liable for:

- (a) Injuries or damages of any kind of nature, direct, consequential or contingent to person or property.
- (b) Any expenses incurred by the owner to repair, replace or rework any allegedly defective item.
- (c) Any loss, cost, forfeiture or damages (including loss of profits; loss of crops; loss because of delay in field operations; any expense or loss incurred for labor, supplies, substitute machine rental; liabilities of the owner to its customers or third persons; and all other consequential damages, losses, liabilities or damages for any other reasons; whether direct or indirect, and whether or not resulting from or contributed to by the default or negligence of the Company, its agents, employees and subcontractors which might be claimed as a result of the use or failure of the equipment delivered.

The Company's liability based on this limited warranty or any other applicable laws shall be limited to replacement or refund of the purchase price of the product.

The limited warranty extended herein gives you specific rights and you may also have other rights which vary from state to state. Neither the dealer nor the Company personnel has the authority to make any representation or to modify the terms and limitations of this warranty in any way. Other than the limited warranty extended hereby, there is no other expressed warranty in connection with the design, safety or use of any of the Company's products except as to title. All implied warranties are expressly disclaimed pursuant to the terms of this warranty.

3. CUSTOM WORK

If the Machine is used for commercial purposes, such as custom work, the period warranted for the Machine is limited to 180 days from the date of delivery to the first registered owner and does not cover any labor charges incurred.

4. RENTAL

If the Machine is used for rental purposes the period warranted for the Machine is limited to thirty (30) days from the date of delivery to the first registered owner and does not cover any labor charges incurred.

5. REGISTRATION

In order to qualify for coverage on this limited warranty, the product and name of the original purchaser must be registered with the Company by mailing a completed Machine Pre-Delivery Checklist and Warranty Registration along with a copy of the dealer's invoice to the first registered owner to the Company within fourteen (14) days after the date of delivery to the original purchaser.

6. WARRANTY SERVICE

Warranty Service must be performed by a dealer authorized by BEFCO. If the warranty service requested is approved, the owner shall pay only for labor beyond the rate allowed, for overtime labor, and for any mileage charge for transporting the equipment to and from the dealer's shop. It is assumed that the dealer has the appropriate general and special tools to service the Machine. Time required for replacement of knives, oil, grease and to remove excessive dirt from the Machine is not subject to reimbursement by the Company. The owner is required to clean the Machine before presenting it to the dealer for service work. The Machine must be delivered within thirty (30) days after failure date by the owner to the dealer to be eligible for warranty consideration.

7. UNAPPROVED SERVICE OR MODIFICATION

All obligations of the Company under this limited warranty shall be terminated if:

- (a) Proper service and operation Instructions, as outlined in the Operator's Manual and on the instruction sticker on the Machine, are not followed.
- (b) The Machine is modified or altered in any way not approved by the Company.
- (c) The Company does not receive a copy of the dealer's invoice to the first registered owner within fourteen (14) days from the date of delivery.
- (d) The Company has not been paid in full, by the dealer, for the Machine.

8. ACCIDENTS AND NORMAL MAINTENANCE

This limited warranty covers defective material and workmanship. It does not cover depreciation or damage caused by normal wear, accidents, improper maintenance, or improper use. The costs of normal maintenance or repairs for accidents or improper use, and related labor, will be borne by the owner.

GENERAL SELLING CONDITIONS

The purpose of the **Befco**® Sales Program is two-fold. First, the program is designed to offer **Befco** dealers, distributors and retailers purchasing directly from **Befco** (each direct purchaser, referred to as "Buyer") an incentive for early booking of orders and to provide financing for Buyers to maintain an adequate inventory of **Befco** brand wholegoods (the "Equipment") prior to and during the selling season. Second, the program enables **Befco** to plan production requirements more accurately in order to make Equipment available on a timely basis. This combination of incentives and financing places **Befco** and its Buyers in a position to achieve a greater market share within a competitive environment. Although **Befco** offers quantity discounts, **Befco** does not require any **Befco** Buyer to purchase or maintain any minimum quantity of Equipment. The **Befco** Buyer may elect at its sole discretion to purchase a sufficient quantity of Equipment to maintain a regular inventory, or may elect to order Equipment only as desired or needed to meet custom requests. The inventory program and level of inventory shall be in the Buyer's discretion. All such orders will be processed in accordance with the Sales Program and these General Selling Conditions in effect. The following information provides details of the **Befco** Sales Program Terms and Conditions.

1. Requirements to Qualify: The terms of sale to Buyers are applicable only to Equipment purchased directly from **Befco**. **Products covered by any order accepted by Befco will be shipped at prices, terms and discounts in effect at time of order unless otherwise specified. The terms and conditions contained herein are subject to change without notice.**

2. Credit Approval: All orders or shipping instructions will be subject to approval by **Befco** prior to shipment. Copies of current Buyer's financial statements are required annually, and signed Security Agreements must be on file where applicable.

3. Trade Discounts: A trade discount may be allowable pursuant to **Befco's** current suggested list price on Equipment.

4. Qualifying and Non-Qualifying Buyers: **Befco** has the right to classify Buyers as either qualifying or non-qualifying; thereby changing the trade discount as indicated in the schedule of Terms and Discounts.

5. Accumulative Quantity Discounts: Accumulative Quantity Discounts are allowed on all **Befco** Equipment and accessories to **Befco Buyers** and are subject to the following conditions:

- Accumulative Quantity Discounts accumulate with each new order, but are not retroactive and will apply only during periods as defined in the current suggested retail price listing or schedule of Terms and Discounts.
- Shipments of Pre-Season Orders will be made at the Company's convenience.
- The Accumulative Quantity Discount is calculated after deducting the Trade Discount.
- Units not paid by the due date will be subject to loss of the Accumulative Quantity Discount plus 1% monthly service charge until paid in full.

6. Cash Discount: Cash discounts are determined by the date of invoice to the Buyer and are calculated on the net balance after all applicable discounts. See specific programs for schedule of cash discounts.

7. Settlement: Payment for Equipment is due immediately following delivery to Buyer's customer, or as specified by invoice due date whichever is earlier. **Any equipment not paid for immediately after delivery to Buyer's customer is considered "out-of-trust" and all discounts are voided and full list price shall be immediately due and payable.**

8. Past Dues & Legal: Past due accounts will have a service charge of 1% per month. Cost of attorney fees for collections of past due accounts will be borne by the Buyer.

9. Requested Shipping Dates & Discounts: Pre-Season Orders will be shipped at **Befco's** convenience. Refusal by the Buyer to accept shipment will disqualify the order. It is the intent of **Befco** to keep freight costs to a minimum, therefore requesting specific shipping dates is not acceptable.

10. Freight Policy:

- All prices are F.O.B. Rocky Mount, North Carolina.
- Pre-Season at **Befco's** convenience. The rate is published each year in the **Befco Terms and Discounts** freight rate section.
- No freight will be charged if the Buyer picks up the Equipment at the Rocky Mount factory.
- Emergency and urgent In-Season shipments will be shipped LTL freight collect.**
- Units from depot outside Rocky Mount, North Carolina, will be shipped LTL Freight Collect. This is in addition to a back freight charge.
- All freight invoices are due Net 30 Days. Past due freight invoices will be charged the standard 1% per month service charge.
- Befco** is not responsible for Equipment or parts damaged or lost in transit.
- The Buyer is responsible for filing a freight claim with the trucking company for lost or damaged Equipment.
- Any applicable duties or tariffs will be the responsibility of and must be paid by the Buyer or other party receiving the order.
- All parts orders are shipped F.O.B. Rocky Mount, N.C.

11. Buyer Inspection/Acceptance; Returns: Buyer shall inspect all Equipment within ten (10) days following delivery (the "Inspection Period") and shall notify the freight forwarder and **Befco** of any claim for damages or shortages. To reject a unit of Equipment for nonconformity with the specifications set forth in **Befco's** documentation for that unit in effect at the time of Buyer's purchase order for such unit, Buyer shall notify **Befco**, within the Inspection Period, in writing of its rejection and shall promptly return the rejected unit in original condition to **Befco**, with insurance and freight prepaid. After receipt of the properly rejected unit, **Befco** at its option shall either repair or replace such properly rejected unit or refund any purchase price paid by Buyer, along with Buyer's return cost of transportation. **Befco** will prepay transportation charges for repaired/replacement units back to Buyer and will reimburse Buyer for the cost of transportation incurred by Buyer in connection with the return of properly rejected units. Any unit not properly rejected within the Inspection Period shall be deemed accepted.

12. Standard Limited Warranty: Buyer shall pass on to his customers **Befco's** standard limited warranty or warranties for the **Befco** Equipment, as such warranty or warranties may be amended from time to time by **Befco**. **Befco** shall not be liable for any other warranties or similar obligation made or given by Buyer.

Except for the standard limited warranty to end user customers of Befco Equipment; Befco grants no other warranties, express or implied, by statute or otherwise, regarding the equipment, their fitness for any purpose, their quality, their merchantability or otherwise. In no event shall Befco be liable for any special, consequential or incidental damages for breach of warranty or any special, consequential or incidental damages, including injury or damage to business, earnings, profits or goodwill suffered by Buyer or any other person and caused directly or indirectly by the equipment sold.

13. Technical and Price Information: Technical information provided in the catalog is approximate. **Befco** reserves the right to modify or improve the models listed for technical or commercial purposes and all prices are subject to change without notice.

BEFCO



BEFCO, Inc.
1781 South Wesleyan Blvd.
P.O. Box 6036
Rocky Mount, NC 27802-6036
Tel: 252.977.9920 - Fax: 252.977.9718
www.befco.com



All rights reserved. It is unlawful to copy, reprint or use any of the information or details indicated in this document without the expressed permission of BEFCO, Inc. Rocky Mount, NC. Technical information provided in this document is approximate, the Company reserves the right to modify or improve the models shown for technical or commercial purposes. Pictures in this manual do not necessarily show the machine as delivered.